

# Panasonic®

LCD Projector **Commercial Use**

## Operating Instructions

---

Model No. **PT-L720U**  
**PT-L520U**

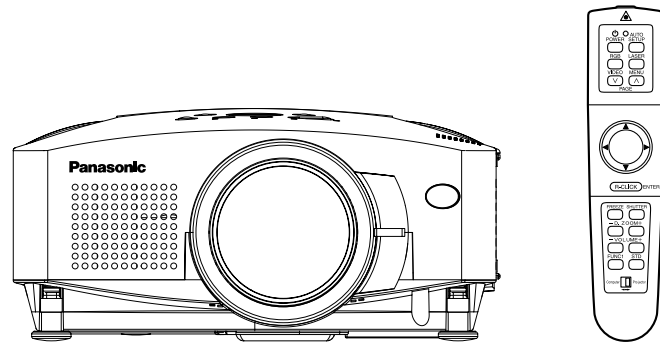

Before operating this product, please read the instructions carefully and save this manual for future use.

# Dear Panasonic Customer:

This instruction booklet provides all the necessary operating information that you might require. We hope it will help you to get the most performance out of your new product, and that you will be pleased with your Panasonic LCD projector.

The serial number of your product may be found on its back. You should note it in the space provided below and retain this booklet in case service is required.

Model number: **PT-L720U / PT-L520U**

Serial number: \_\_\_\_\_

## IMPORTANT SAFETY NOTICE

**WARNING: TO REDUCE THE RISK OF FIRE OR ELECTRIC SHOCK, DO NOT EXPOSE THIS PRODUCT TO RAIN OR MOISTURE.**

**Power Supply:** This LCD Projector is designed to operate on 100 V – 240 V, 50 Hz/60 Hz AC, house current only.

**CAUTION:** The AC power cord which is supplied with the projector as an accessory can only be used for power supplies up to 125 V, 10 A. If you need to use higher voltages or currents than this, you will need to obtain a separate 250 V power cord. If you use the accessory cord in such situations, fire may result.



The lightning flash with arrowhead symbol, within an equilateral triangle, is intended to alert the user to the presence of uninsulated "dangerous voltage" within the product's enclosure that may be of sufficient magnitude to constitute a risk of electric shock to persons.



The exclamation point within an equilateral triangle is intended to alert the user to the presence of important operating and maintenance (servicing) instructions in the literature accompanying the product.

**CAUTION:** This equipment is equipped with a three-pin grounding-type power plug. Do not remove the grounding pin on the power plug. This plug will only fit a grounding-type power outlet. This is a safety feature. If you are unable to insert the plug into the outlet, contact an electrician. Do not defeat the purpose of the grounding plug.

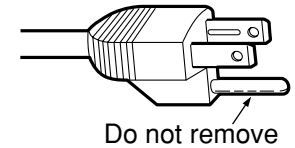

### WARNING:

This equipment has been tested and found to comply with the limits for a Class B digital device, pursuant to Part 15 of the FCC Rules. These limits are designed to provide reasonable protection against harmful interference in a residential installation. This equipment generates, uses, and can radiate radio frequency energy and, if not installed and used in accordance with the instructions, may cause harmful interference to radio communications. However, there is no guarantee that interference will not occur in a particular installation. If this equipment does cause harmful interference to radio or television reception, which can be determined by turning the equipment off and on, the user is encouraged to try to correct the interference by one or more of the following measures:

- Reorient or relocate the receiving antenna.
- Increase the separation between the equipment and receiver.
- Connect the equipment into an outlet on a circuit different from that to which the receiver is connected.
- Consult the dealer or an experienced radio/TV technician for help.

**CAUTION:** Any unauthorized changes or modifications to this equipment will void the users authority to operate.

### Declaration of Conformity

Model Number: PT-L720U / PT-L520U  
Trade Name: **Panasonic**  
Responsible party: Matsushita Electric Corporation of America.  
Address: One Panasonic Way Secaucus New Jersey 07094  
Telephone number: 1-800-528-8601 or 1-800-222-0741  
Email: pbtsservice@panasonic.com

This device complies with Part 15 of the FCC Rules, Operation is subject to the following two conditions: (1) This device may not cause harmful interference, and (2) this device must accept any interference received, including interference that may cause undesired operation.

# Contents

## Preparation

<b>IMPORTANT SAFETY NOTICE</b> .....	2
<b>Precautions with regard to safety</b> ....	5
<b>Accessories</b> .....	9
<b>Precautions on handling</b> .....	10
<b>Location and function of each part</b> ...12	
About the RGB INPUT indicator.....	17
About the automatic setup function.....	17
<b>Using the remote control unit</b> .....	18
Laser beam pointer.....	18
Wireless mouse.....	19
Inserting the batteries.....	20
Operating range.....	20
<b>Connections</b> .....	21
Notes on connections.....	21
Example of connecting to video equipment.....	22
Example of connecting to computer.....	23
<b>Setting-up</b> .....	24
Projection methods.....	24
Projector position.....	24
Projection distances.....	25
<b>Basic Operation</b>	
<b>Starting to use</b> .....	26
Turning on the power.....	26
Turning off the power.....	27
<b>On-screen menus</b> .....	28
Menu screens.....	28
Menu operation guide.....	30
Unavailable on-screen menu items.....	30
Returning to the previous screen.....	30
Returning a setting to the factory default.....	31
<b>Using the freeze function</b> .....	31
<b>Using the D.ZOOM (digital zoom) function</b> .....	32
<b>Correcting keystone distortion</b> .....	33
<b>Adjusting the picture</b> .....	34
PICTURE MODE.....	34
Color Hue Setting.....	34
COLOR.....	35
TINT.....	35
BRIGHT.....	35
CONTRAST.....	35
SHARPNESS.....	35
Noise Reduction(NR).....	35

TV SYSTEM.....	35
WHITE BALANCE R/G/B.....	36
SIGNAL MODE.....	36
Projecting sRGB-compatible pictures.....	36
<b>Adjusting the position</b> .....	37
HORIZONTAL POSITION.....	37
VERTICAL POSITION.....	37
DOT CLOCK.....	37
CLOCK PHASE.....	37
ASPECT.....	38
RESIZING.....	39

## Advanced Operation

<b>Option settings</b> .....	40
OSD.....	40
AUTO KEYSTN.....	40
AUTO RGB IN.....	40
RGB2 SELECT.....	40
RGB Y·PB·PR.....	40
SXGA MODE.....	41
BACK COLOR.....	41
FRONT/REAR.....	41
DESK/CEILING.....	41
FAN CONTROL.....	41
LAMP POWER.....	41
LAMP RUNTIME.....	41
FUNC 1.....	42
CONTROL KEY.....	42

<b>Using the shutter function</b> .....	42
<b>Changing the display language</b> .....	42
<b>Using the INDEX WINDOW function</b> ...43	
<b>Using the SERIAL connector</b> .....	44

## Others

<b>Indicators</b> .....	46
<b>Cleaning and replacing the air filter</b> ...48	
<b>Replacing the lamp unit</b> .....	49
<b>Before calling for service</b> .....	52
<b>Specifications</b> .....	54
<b>List of compatible signals</b> .....	56
<b>Dimensions</b> .....	57
<b>Trademark acknowledgements</b> .....	57
<b>NOTES IMPORTANTES</b>	
<b>CONCERNANT LA SÉCURITÉ</b> ...58	
<b>Précautions de sécurité</b> .....	59
<b>Précautions de manipulation</b> .....	63
<b>Remplacement du bloc de lampe</b> ...65	

# Precautions with regard to safety

## WARNING

**If a problem occurs (such as no image or no sound) or if you notice smoke or a strange smell coming from the projector, turn off the power and disconnect the power cord from the wall outlet.**

- Do not continue to use the projector in such cases, otherwise fire or electric shocks could result.
- Check that no more smoke is coming out, and then contact an Authorised Service Center for repairs.
- Do not attempt to repair the projector yourself, as this can be dangerous.

**Do not install this projector in a place which is not strong enough to take the full weight of the projector.**

- If the installation location is not strong enough, it may fall down or tip over, and severe injury or damage could result.

**Installation work (such as ceiling suspension) should only be carried out by a qualified technician.**

- If installation is not carried out correctly, there is the danger that injury or electric shocks may occur.

**If foreign objects or water get inside the projector, or if the projector is dropped or the cabinet is broken, turn off the power and disconnect the power cord from the wall outlet.**

- Continued use of the projector in this condition may result in fire or electric shocks.
- Contact an Authorised Service Center for repairs.

**Do not overload the wall outlet.**

- If the power supply is overloaded (for example, by using too many adapters), overheating may occur and fire may result.

**Do not remove the cover or modify it in any way.**

- High voltages which can cause fire or electric shocks are present inside the projector.
- For any inspection, adjustment and repair work, please contact an Authorised Service Center.

**Clean the power cord plug regularly to prevent it from becoming covered in dust.**

- If dust builds up on the power cord plug, the resulting humidity can damage the insulation, which could result in fire. Pull the power cord out from the wall outlet and wipe it with a dry cloth.
- If not using the projector for an extended period of time, pull the power cord plug out from the wall outlet.

**Do not do anything that might damage the power cord or the power cord plug.**

- Do not damage the power cord, make any modifications to it, place it near any hot objects, bend it excessively, twist it, pull it, place heavy objects on top of it or wrap it into a bundle.
- If the power cord is used while damaged, electric shocks, short-circuits or fire may result.
- Ask an Authorised Service Center to carry out any repairs to the power cord that might be necessary.

**Do not handle the power cord plug with wet hands.**

- Failure to observe this may result in electric shocks.

**Insert the power cord plug securely into the wall outlet.**

- If the plug is not inserted correctly, electric shocks or overheating could result.
- Do not use plugs which are damaged or wall outlets which are coming loose from the wall.

**Do not place the projector on top of surfaces which are unstable.**

- If the projector is placed on top of a surface which is sloped or unstable, it may fall down or tip over, and injury or damage could result.

**Do not place the projector into water or let it become wet.**

- Failure to observe this may result in fire or electric shocks.

**Do not place liquid containers on top of the projector.**

- If water spills onto the projector or gets inside it, fire or electric shocks could result.
- If any water gets inside the projector, contact an Authorised Service Center.

**Do not insert any foreign objects into the projector.**

- Do not insert any metal objects or flammable objects into the projector or drop them onto the projector, as doing so can result in fire or electric shocks.

**Keep the remote control unit out of the reach of children, and do not look into the laser beam or point it towards other people.**

- If the laser beam which is emitted by the remote control unit transmitter is pointed directly into the eyes, it may cause visual ability to be impaired.

**Do not allow the + and - terminals of the batteries to come into contact with metallic objects such as necklaces or hairpins.**

- Failure to observe this may cause the batteries to leak, overheat, explode or catch fire.
- Store the batteries in a plastic bag and keep them away from metallic objects.

**During a thunderstorm, do not touch the projector or the cable.**

- Electric shocks can result.

**Do not use the projector in a bath or shower.**

- Fire or electric shocks can result.

**Do not look into the lens while the projector is being used.**

- Strong light is emitted from the projector's lens. If you look directly into this light, it can hurt and damage your eyes.

**Do not bring your hands or other objects close to the air outlet port.**

- Heated air comes out of the air outlet port. Do not bring your hands or face, or objects which cannot withstand heat close to this port, otherwise burns or damage could result.

**When replacing the lamp, allow it to cool for at least one hour before handling it.**

- The lamp cover gets very hot, and contact with it can cause burns.

**Before replacing the lamp, be sure to unplug the power cord from the power outlet.**

- Electric shocks or explosions can result if this is not done.

**Caution****Do not cover the air inlet or the air outlet.**

- Doing so may cause the projector to overheat, which can cause fire or damage to the projector.

**Do not set up the projector in humid or dusty places or in places where the projector may come into contact with smoke or steam.**

- Using the projector under such conditions may result in fire or electric shocks.

**When disconnecting the power cord, hold the plug, not the cord.**

- If the power cord itself is pulled, the cord will become damaged, and fire, short-circuits or serious electric shocks may result.

**Always disconnect all cables before moving the projector.**

- Moving the projector with cables still attached can damage the cables, which could cause fire or electric shocks to occur.

**Do not place any heavy objects on top of the projector.**

- Failure to observe this may cause the projector to become unbalanced and fall, which could result in damage or injury.

**Do not short-circuit, heat or disassemble the batteries or place them into water or fire.**

- Failure to observe this may cause the batteries to overheat, leak, explode or catch fire, and burns or other injury may result.

**When inserting the batteries, make sure the polarities (+ and -) are correct.**

- If the batteries are inserted incorrectly, they may explode or leak, and fire, injury or contamination of the battery compartment and surrounding area may result.

**Use only the specified batteries.**

- If incorrect batteries are used, they may explode or leak, and fire, injury or contamination of the battery compartment and surrounding area may result.

**Do not mix old and new batteries.**

- If the batteries are inserted incorrectly, they may explode or leak, and fire, injury or contamination of the battery compartment and surrounding area may result.

**Do not put your weight on this projector.**

- You could fall or the projector could break, and injury may result.
- Be especially careful not to let young children climb onto the projector.

**Disconnect the power cord plug from the wall outlet as a safety precaution before carrying out any cleaning.**

- Electric shocks can result if this is not done.

**Ask an Authorised Service Center to clean inside the projector at least once a year.**

- If dust is left to build up inside the projector without being cleaned out, it can result in fire or problems with operation.
- It is a good idea to clean the inside of the projector before the season for humid weather arrives. Ask your nearest Authorised Service Center to clean the projector when required. Please discuss with the Authorised Service Center regarding cleaning costs.



**We are constantly making efforts to preserve and maintain a clean environment. Please take non repairable units back to your dealer or a recycling company.**

**NOTICE:**

- This product has a High Intensity Discharge (HID) lamp that contains a small amount of mercury. It also contains lead in some components. Disposal of these materials may be regulated in your community due to environmental considerations. For disposal or recycling information please contact your local authorities, or the Electronics Industries Alliance: <<http://www.eiae.org>>

# Accessories

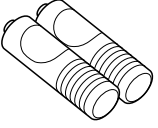
Check that all of the accessories shown below have been included with your projector.

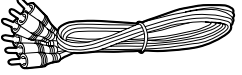
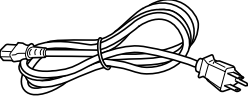
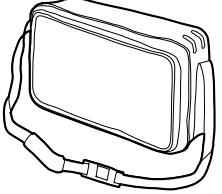
<p>Remote control unit (N2QAEA000008 x1)</p> 	<p>AAA batteries for remote control unit (x2)</p> 	<p>RGB signal cable [3.0 m (9'10"), K1HB15FA0001 x1]</p> 
	<p>Video/Audio cable [3.0 m (9'10"), K2KA2FA00001 x 1]</p> 	<p>Power cord (K2CG3FZ00008 x1)</p> 
<p>Carrying bag (TPEP007 x1)</p> 		

# Precautions on handling

## Cautions regarding transportation

**Be sure to attach the lens cover before transporting the projector.**

The projection lens is extremely susceptible to vibration and shocks. When carrying the projector, use the accessory carrying bag.

## Cautions regarding setting-up

Observe the following at all times when setting up the projector.

**Avoid setting up in places which are subject to vibration or shocks.**

If the projector is set up in locations with strong vibration, such as near a motor, or if it is installed inside a vehicle or on board a ship, the projector may be subjected to vibration or shocks which can damage the internal parts and cause malfunctions or accidents. Accordingly, set up the projector in a place which is free from such vibrations and shocks.

**Do not set up the projector near high-voltage power lines or near motors.**

The projector may be subject to electromagnetic interference if it is set up near high-voltage power lines or motors.

**If installing the projector to the ceiling, ask a qualified technician to carry out all installation work.**

If the projector is to be suspended from the ceiling, you will need to purchase the separate installation kit (Model No.: ET-PK730). Furthermore, all installation work should only be carried out by a qualified technician.

**If using this projector at high elevations (above 1 400 m), set the FAN CONTROL to HIGH. (Refer to page 41.)**

Failure to observe this may result in malfunctions.

## Notes on use

**In order to get the best picture quality**

If outside light or light from indoor lamps is shining onto the screen, the images projected will not have good contrast. Draw curtains or blinds over any windows and turn off any fluorescent lights near the screen to prevent reflection.

**Do not touch the surfaces of the lens with your bare hands.**

If the surface of the lens becomes dirty from fingerprints or anything else, this will be magnified and projected onto the screen. Moreover, when not using the projector, retract the lens and then cover it with the accessory lens cover.

### About the screen

If the screen you are using is dirty, damaged or discolored, attractive projections cannot be obtained. Do not apply any volatile substances to the screen, and do not let it become dirty or damaged.

### About the lamp

The lamp may need to be replaced earlier due to variables such as a particular lamp's characteristics, usage conditions and the installation environment, especially when it is subjected to a continuous use for more than 10 hours.

**Before carrying out cleaning and maintenance, be sure to disconnect the power cord plug from the wall outlet.**

**Wipe the cabinet with a soft, dry cloth.**

If the cabinet is particularly dirty, soak the cloth in water with a small amount of neutral detergent in it, squeeze the cloth very well, and then wipe the cabinet. After cleaning, wipe the cabinet dry with a dry cloth.

**If using a chemically-treated cloth, read the instructions supplied with the cloth before use.**

Do not wipe the lens with a cloth that is dusty or which produces lint.

If any dust or lint gets onto the lens, such dust or lint will be magnified and projected onto the screen. Use a blower to clean any dust and lint from the lens surface, or use a soft cloth to wipe off any dust or lint.

# Location and function of each part

## Projector <Top, right and front>

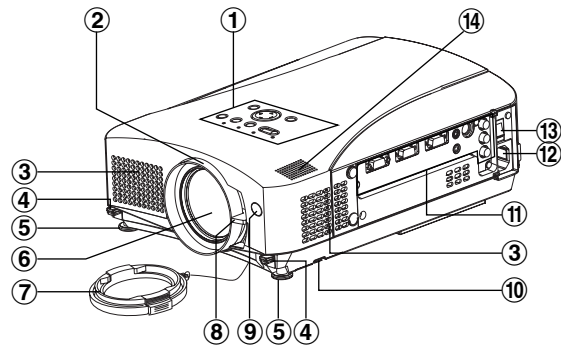

① **Projector control panel**  
(page 14)

② **Focus ring**  
(page 27)

③ **Air inlet ports**  
Do not cover these ports.

④ **Leg adjuster buttons(L/R)**  
(page 26)

These buttons are used to unlock the front adjustable legs. Press to adjust the angle of tilt of the projector.

⑤ **Front adjustable legs(L/R)**  
(page 26)

⑥ **Projection lens**

⑦ **Lens cover**

⑧ **Zoom knob**  
(page 27)

⑨ **Remote control signal receptor**  
(page 20)

⑩ **Air filter**  
(page 48)

⑪ **Connector panel**  
(page 16)

⑫ **Power input socket (AC IN)**  
(page 26)

The accessory power cord is connected here. Do not use any power cord other than the accessory power cord.

⑬ **MAIN POWER switch**  
(pages 26 and 27)

⑭ **Speaker**

## Projector <Back and bottom>

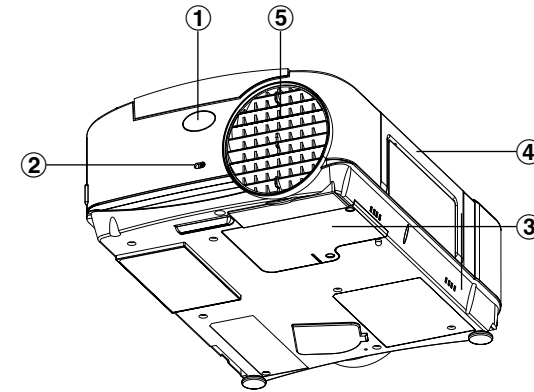

① **Remote control signal receptor**  
(page 20)

② **Security lock**

This can be used to connect a commercially-available theft-prevention cable (manufactured by Kensington). This security lock is compatible with the Microsaver Security System from Kensington. Contact details for this company are given below.  
Kensington Technology Group  
ACCO Brands Inc.  
2855 Campus Drive  
San Mateo, CA 94403 USA  
Tel (650)572-2700  
Fax (650)572-9675  
<http://www.kensington.com/>  
<http://www.gravis.com/>

**NOTE:**

- Information given above may be changed in future.

③ **Lamp unit holder**  
(page 49)

④ **Carrying handle**

⑤ **Air outlet port**

Do not cover this port.

When you change the direction of

the air flow out of the outlet port, make sure that the MAIN POWER is "OFF" and the projector is cooled down.

### WARNING

**Do not bring your hands or other objects close to the air outlet port.**

- Heated air comes out of the air outlet port. Do not bring your hands or face, or objects which cannot withstand heat close to this port, otherwise burns or damage could result.

**NOTE:**

- During projection of an image, the cooling fan will operate, emitting a small noise as it operates. Turning the lamp on or off will cause this noise to increase a little.
- By using the OPTION2 menu to set "LAMP POWER" to "LOW", the operating sound of the fan can be reduced. (Refer to page 41.)

## Remote control unit

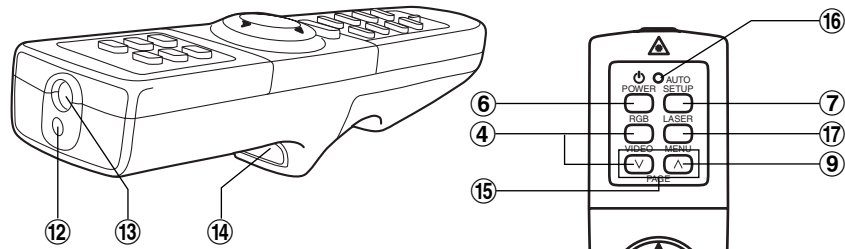

## Projector control panel

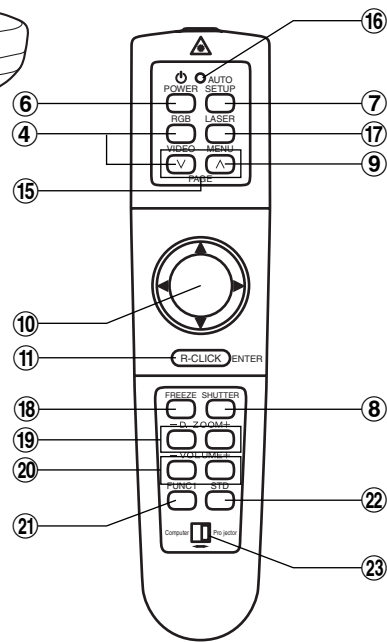
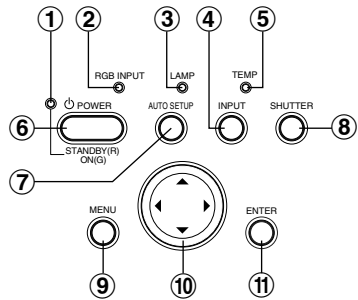

### ① Power indicator (pages 26 and 27)

This indicator illuminates red when the MAIN POWER switch is turned on (standby mode), and illuminates green when the power is turned on and a picture starts to be projected.

### ② RGB INPUT indicator (page 17)

This indicator shows whether a signal is being input to the RGB input connectors (RGB 1 IN/RGB 2 IN). When an input signal is detected, the indicator illuminates.

### ③ LAMP indicator (page 47)

This indicator illuminates when it is time to replace the lamp unit. It flashes if a circuit abnormality is detected.

### ④ Input select (INPUT, RGB, VIDEO) buttons (page 26)

### ⑤ TEMP indicator (page 46)

This indicator illuminates if an abnormally high temperature is

detected inside the projector or around it. If the temperature rises above a certain level, the power supply will be turned off automatically and the indicator will illuminate or flash.

### ⑥ POWER button (pages 26 and 27)

### ⑦ AUTO SETUP button (pages 17 and 26)

If this button is pressed while a picture is being projected, the projection settings will be adjusted automatically in accordance with the signal being input. In addition, the angle of tilt of the projector will be automatically detected and adjusted in order to correct any keystone distortion. ("AUTO SETUP" will appear on the screen during adjustment.) Set "AUTO KEYSTN" in the OPTION1 menu to "OFF" to prevent any deterioration of the picture as a result of keystone correction.

### ⑧ SHUTTER button (page 42)

This button is used to momentarily turn off the picture and sound.

### ⑨ MENU button (pages 28 and 30)

This button is used to display the menu screens. When a menu screen is being displayed, this button can be used to return to a previous screen or to clear the screen.

### ⑩ Arrow (▲▼◀▶) buttons (page 30)

These buttons are used to select and adjust items in the menu screens.

\*When in computer operating mode, these buttons function differently. (page 19)

### ⑪ ENTER button (page 30)

This button is used to accept and to activate items selected in the on-screen menus.

\*When in computer operating mode, this button operates differently. (page 19)

### ⑫ Laser emitter (page 18)

### ⑬ Infrared emitter (page 20)

### ⑭ Click button (page 19)

This button can be used when the operating mode select switch is moved to the left (Computer).

### ⑮ PAGE button (page 19)

This button can be used when the operating mode select switch is moved to the left (Computer).

### ⑯ Operation indicator (page 18)

This indicator illuminates while a laser beam is being emitted (while the LASER button is being pressed). It flashes when any other buttons are being pressed.

### ⑰ LASER button (page 18)

A beam of laser light is emitted while this button is being pressed. This laser beam can be used as a pointer to point to something on the screen.

### ⑱ FREEZE button (page 31)

This button is used to momentarily freeze projection so that a still picture is displayed.

### ⑲ D.ZOOM +/- buttons (page 32)

These buttons are used to enlarge the projected image.

### ⑳ VOLUME +/- buttons

These buttons are used to adjust the volume of the sound output from the projector's built-in speaker. Refer to page 28 for details on how to adjust the volume using the buttons on the projector control panel.

### ㉑ FUNCTION (FUNC1) button (pages 33, 42 and 43)

This button is used to enter into the keystone distortion correction mode, and it can be used to split the screen into one frozen image and one moving image (INDEX menu item). Use the FUNC1 item in the OPTION2 menu to select which of these two operations you want to use with this button.

### ㉒ STD (standard) button (page 31)

This button is used to reset the projector adjustment values to the factory default settings.

### ㉓ Operating mode (Computer, Projector) select switch (page 19)

Move this switch to the left side to use the remote control unit to operate a computer, and move it to the right side to operate the projector.



## <Connector panel>

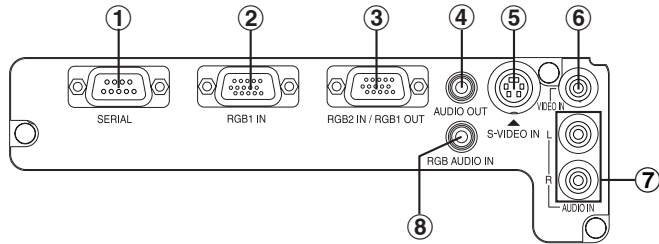

### ① SERIAL connector

(pages 22, 23 and 44)

This connector is used to connect a personal computer to the projector in order to externally control the projector. (RS-232C compatible)

### ② RGB1 IN connector

(pages 22 and 23)

This connector is used to input RGB signals and YPbPr signals.

### ③ RGB2 IN/RGB1 OUT connector

(pages 22, 23 and 40)

This connector is used to input or output RGB signals and YPbPr signals. Use the RGB2 SELECT item in the OPTION1 menu to select whether you want input or output with this connector.

### ④ AUDIO OUT jack

(pages 22 and 23)

This jack is used to output the audio signals which are input to the projector. If audio equipment is connected to this jack, no sound will be output from the built-in speakers.

### ⑤ S-VIDEO IN connector

(pages 22 and 38)

This connector is used to input signals from a S-VIDEO-compatible equipment such as a

video deck. The connector is S1 signal compatible, and it automatically switches between 16:9 and 4:3 aspect ratios in accordance with the type of signal being input.

### ⑥ VIDEO IN jack

(page 22)

This jack is used to input video signals from a video equipment such as a video deck.

### ⑦ AUDIO IN L-R (for VIDEO/S-VIDEO) jacks

(page 22)

Only one system is provided, so connect the appropriate connector when using VIDEO or S-VIDEO.

### ⑧ RGB AUDIO IN jack

(pages 22 and 23)

Only one system is provided, so connect the appropriate connector when using RGB1 or RGB2.

## About the RGB INPUT indicator

The RGB INPUT indicator can be used to check whether an RGB/YPbPr signal is being input. Refer to the table below for details.

RGB INPUT indicator status	Power supply status	
	Standby	On (projecting)
<b>Illuminated</b>	A signal is being input to either the RGB1 IN or RGB2 IN connector.	A signal is being input to the connector selected using the input select buttons.
<b>Switched off</b>	No signal is being input to either the RGB1 IN or RGB2 IN connector.	No signal is being input to the connector selected using the input select buttons.

## About the automatic setup function

If you press the AUTO SETUP button, the items given in the table below will be set automatically. The setting details change according to the signal which is being input. Refer to the table below for details.

	Horizontal/vertical position	Dot clock/clock phase	Auto RGB input select	Automatic keystone correction
<b>VIDEO/S-VIDEO</b>	/	/	/	<b>Yes</b>
<b>YPbPr</b>	/	/	/	<b>Yes</b>
<b>Dot Clock frequency is 100 MHz or higher</b>	<b>Yes</b>	<b>No</b>	/	<b>Yes</b>
<b>Signal other than above</b>	<b>Yes</b>			

### NOTE:

- If the edges of the projected picture are indistinct, or if a dark picture is being projected, the automatic setup processing may stop automatically before it is complete. If this happens, project a different picture and then press the AUTO SETUP button once more, or make the above adjustments manually.
- If you would like to make further adjustments to the picture, use the menu commands which are listed on page 28 and subsequent pages.

# Using the remote control unit

## Laser beam pointer

The laser beam emitted from the remote control can be used as a pointer by pointing forward to the screen.

While the LASER button is being pressed, the laser beam is being emitted and the operating indicator illuminates.

Do not look into the laser emitter of the remote control unit or point the laser beam towards other people, otherwise damage to eyes may occur.

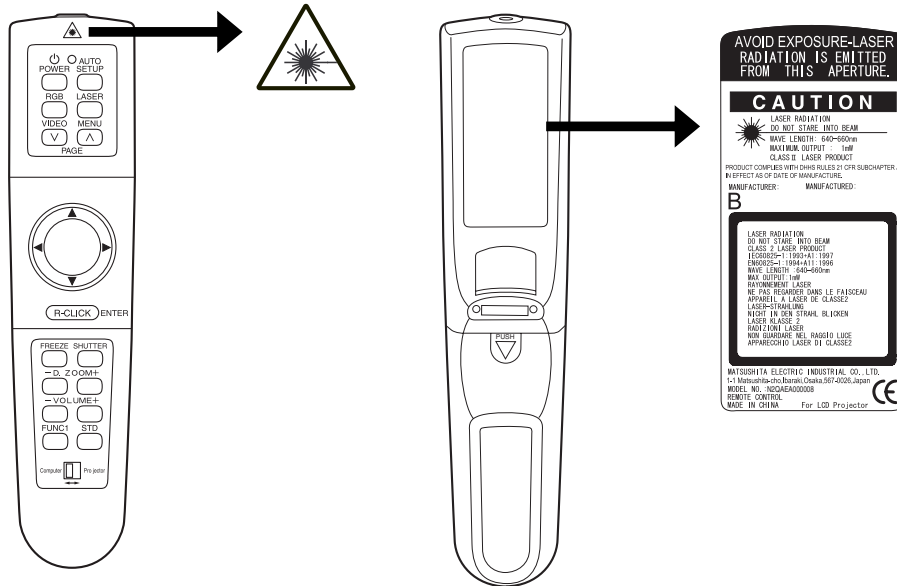

## Caution

- Use of controls or adjustments or performance of procedures other than those specified herein may result in hazardous radiation exposure.
- This remote control unit cannot be repaired.

## Wireless mouse

By connecting the optional wireless mouse receiver (ET-RMRC1) to a personal computer, it is possible to operate a personal computer, using the remote control unit.

Connect the optional wireless receiver to a personal computer in the same manner as connecting a mouse, to the USB port, PS/2 mouse port or ADB port, using the cable provided with the wireless mouse receiver. (Refer to the operating instructions of the wireless mouse receiver for details on how to connect to a personal computer or on the types of personal computers that can be used.)

## Operation

To operate a personal computer with the remote control, move the operating mode (Computer, Projector) select switch to the left (Computer).

### • ▲▼◀▶ buttons

While gently pressing the button with your thumb, move your thumb up, down and to the left and right to move the mouse cursor in the same direction. If you press gently, the cursor will move slowly, and if you press more firmly, the cursor will move more quickly.

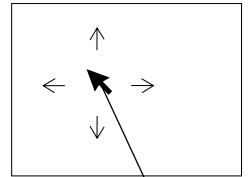

Mouse cursor

### • Click button

The Click button on the underside of the remote control unit can be used in place of the mouse button on a mouse with only a single button. It corresponds to the left mouse button on a mouse with two buttons.

### • ENTER (R-CLICK) button

The ENTER (R-CLICK) button at the front of the remote control unit corresponds to the right mouse button on a mouse with two buttons.

### • PAGE button

This button operates in the same way as the cursor up and down buttons on the computer keyboard.

(Only when the wireless mouse receiver is connected to a personal computer by means of the USB cable.)

### • LASER button

A beam of laser light is emitted while this button is being pressed. This beam of laser light can be used as a pointer by directing it toward the screen.

# Inserting the batteries

## ① Open the cover.

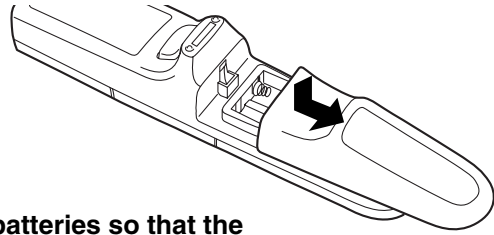

## ② Insert the batteries so that the polarities are correct, and then close the cover.

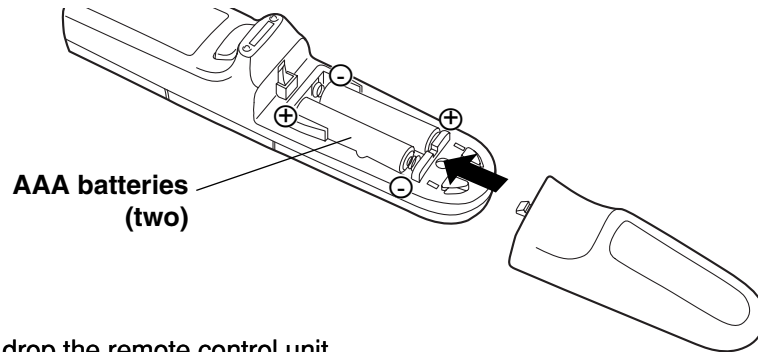

### NOTE:

- Do not drop the remote control unit.
- Keep the remote control unit away from liquids.
- Remove the batteries if not using the remote control unit for long periods.
- Do not use rechargeable batteries.

## Operating range

If the remote control unit is held so that it is facing directly in front of the remote control signal receptors on the front or rear of the projector, the operating range is within approximately 7 m (23') from the surfaces of the receptors. Furthermore, the remote control unit can be operated from an angle of  $\pm 30^\circ$  to the left or right and  $\pm 15^\circ$  above or below the receptors.

### NOTE:

- If there are any obstacles in between the remote control unit and the receivers, the remote control unit may not operate correctly.
- If strong light is allowed to shine onto the remote control signal receiver, correct remote control operation may not be possible. Place the projector as far away from light sources as possible.
- If facing the remote control unit toward the screen to operate the projector, the operating range of the remote control unit will be limited by the amount of light reflection loss caused by the characteristics of the screen used.

# Connections

## Notes on connections

- Read the instruction manual for each system component carefully before connecting it.
- Turn off the power supply for all components before making any connections.
- If the cables necessary for connecting a component to the system are not included with the component or available as an option, you may need to fashion a cable to suit the component concerned.
- If there is a lot of jitter in the video signal which is input from the video source, the picture on the screen may flicker. In such cases, it will be necessary to connect a TBC (time base corrector).
- The projector has a built-in speaker. However, you will need to connect a separate audio system to the AUDIO OUT jack if your needs specify high sound volumes. No sound will come out of the projector's built-in speaker while the AUDIO OUT jack is being used.
- It may not be possible to connect some types of computer. Refer to the list of compatible signals on page 56.
- The pin layout and signal names for the S-VIDEO IN connector are shown below.

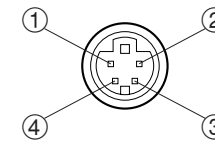

External view

Pin No.	Signal
①	Earth (Luminance signal)
②	Earth (Color signal)
③	Luminance signal
④	Color signal

- The pin layout and signal names for the RGB/YPbPr (RGB1 IN/RGB2 IN) connector are shown below.

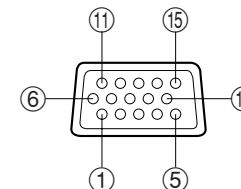

External view

Pin No.	Signal
①	R/Pr
②	G/G·SYNC/Y
③	B/Pb
⑫	SDA
⑬	HD/SYNC
⑭	VD
⑮	SCL

Pin ⑨ is spare.

Pins ④–⑧, ⑩ and ⑪ are for earth.

Pins ⑫ and ⑮ functions are only valid when supported by the computer

## Example of connecting with video equipments

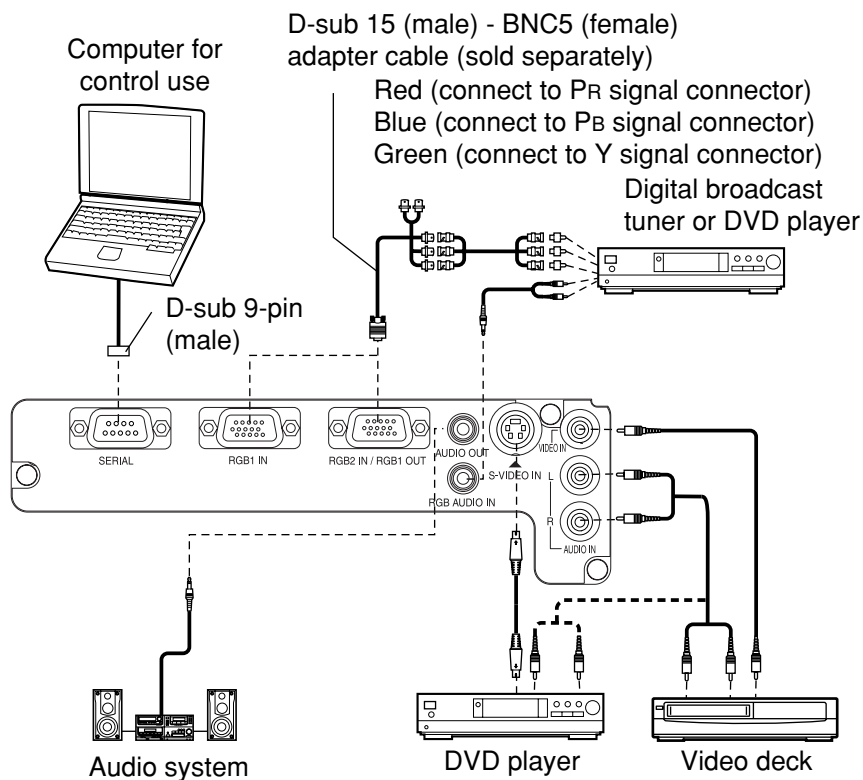

### NOTE:

- Only one audio system circuit is available for the AUDIO IN L-R jacks for S-VIDEO/VIDEO signals, so if you wish to change the audio input source, you will need to remove and insert the appropriate plugs.
- Only one audio system circuit is available for the RGB AUDIO IN jacks, so if you wish to change the audio input source, you will need to remove and insert the appropriate plugs.
- If an audio system is connected to the AUDIO OUT jack, the sound volume balance can be controlled by the remote control unit which is supplied with the projector.
- If the video signal source is connected using a cable with a BNC connector plug, use a BNC/RCA adapter (sold separately) to convert the cable end to an RCA plug-type jack.
- Refer to page 56 for a list of compatible YPbPr signals which can be input to the projector.
- If the signal cables are disconnected or if the power supply for the computer or video deck is turned off while the digital zoom or index window functions are being used, these functions will be cancelled.

## Example of connecting to computer

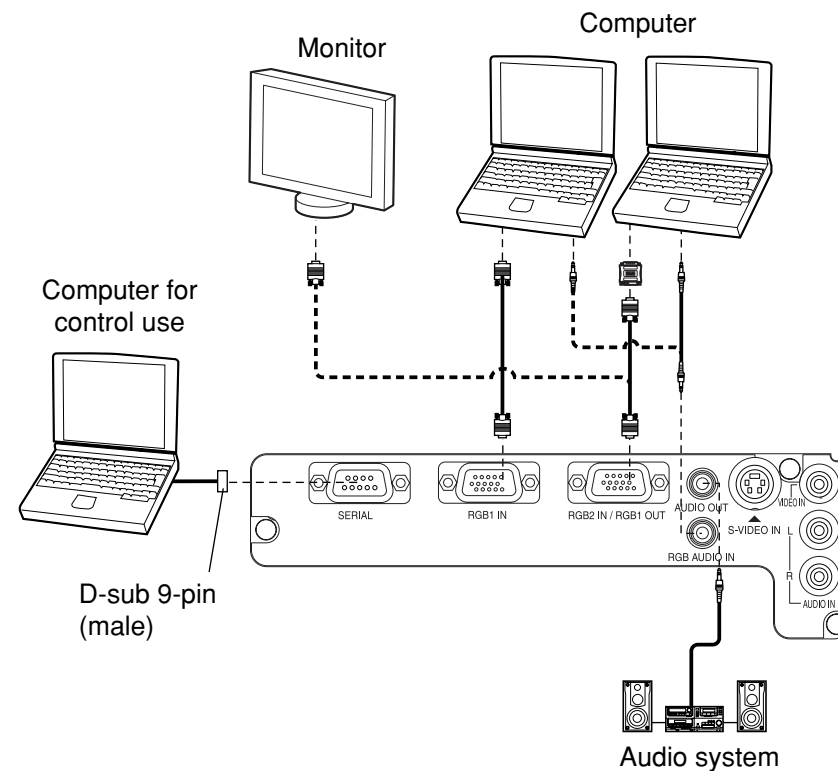

### NOTE:

- It is better to shut down the computer before turning off the MAIN POWER switch of the projector.
- Refer to the list of compatible signals on page 56 for the types of RGB signals which can be input to the projector by connecting a computer.
- Do not input the signal to the RGB2 IN/RGB1 OUT connector when the RGB2 SELECT item in the OPTION1 menu is set to OUTPUT. (Refer to page 40.)

# Setting-up

## Projection methods

In way of installing projector, any one of the following four projection methods are used. Select whichever projection method matches the setting-up method. (The projection method can be set from the OPTION2 menu. Refer to page 41 for details.)

		DESK/CEILING	
		DESK	CEILING
FRONT/REAR	FRONT		
	REAR		

### NOTE:

- You will need to purchase the separate ceiling bracket (ET-PK730) when using the ceiling installation method.

## Projector position

<Units: mm (inch)>

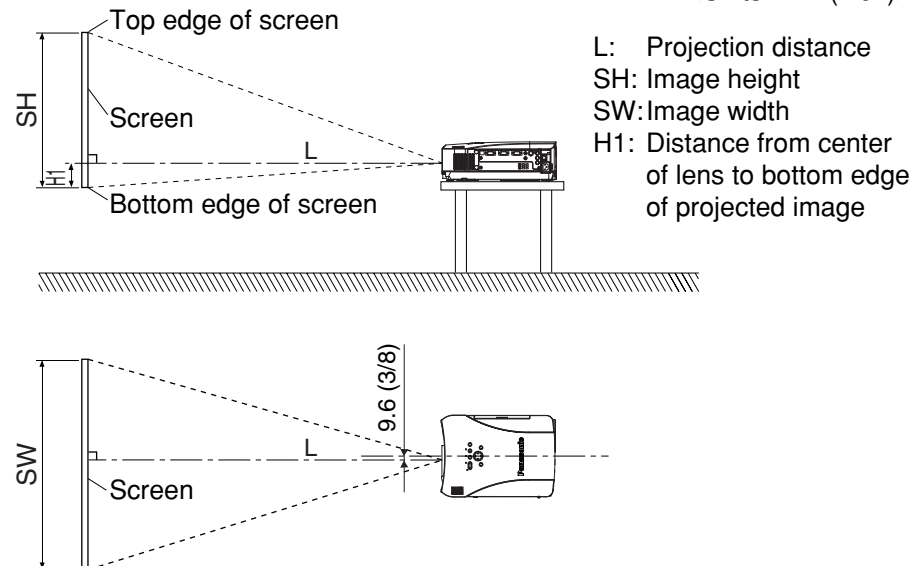

## Projection distances

Screen size (4:3)			Projection distance (L)		Height position (H1)
Diagonal length	Height (SH)	Width (SW)	Wide (LW)	Telephoto (LT)	
1.01 m(40")	0.61 m(2')	0.81 m(2'8")	1.2 m(3'11")	1.5 m(4'11")	0.06 m(2-13/32")
1.27 m(50")	0.76 m(2'6")	1.02 m(3'4")	1.6 m(5'2")	1.9 m(6'2")	0.08 m(3")
1.52 m(60")	0.91 m(3')	1.22 m(4')	1.9 m(6'2")	2.3 m(7'6")	0.09 m(3-19/32")
1.77 m(70")	1.07 m(3'6")	1.42 m(4'8")	2.2 m(7'2")	2.7 m(8'10")	0.11 m(4- 6/32")
2.03 m(80")	1.22 m(4')	1.63 m(5'4")	2.5 m(8'2")	3.1 m(10'2")	0.12 m(4-26/32")
2.28 m(90")	1.37 m(4'6")	1.83 m(6')	2.8 m(9'2")	3.5 m(11'5")	0.14 m(5-13/32")
2.54 m(100")	1.52 m(5')	2.03 m(6'8")	3.1 m(10'2")	3.9 m(12'9")	0.15 m(6")
3.81 m(150")	2.29 m(7'6")	3.05 m(10')	4.7 m(15'5")	5.8 m(19')	0.23 m(9")
5.08 m(200")	3.05 m(10')	4.06 m(13'4")	6.2 m(20'4")	7.8 m(25'7")	0.31 m(12")
6.35 m(250")	3.81 m(12'6")	5.08 m(16'8")	7.8 m(25'7")	9.8 m(32'1")	0.38 m(15")
7.62 m(300")	4.57 m(15')	6.10 m(20')	9.4 m(30'10")	11.8 m(38'8")	0.46 m(18")

Setting-up dimensions which are not given in the above table can be calculated using the formulas below.

If the screen size (diagonal) is SD (m), then the following formula is used to calculate the projection distance for the wide lens position (LW) and the projection distance for the telephoto lens position (LT).

$$LW=0.031 \times SD / 0.0254 - 0.068$$

$$LT=0.0393 \times SD / 0.0254 - 0.066$$

For 16:9 aspect ratios, the following formula can be used to calculate the projection distance.

$$LW=0.034 \times SD / 0.0254 - 0.068$$

$$LT=0.043 \times SD / 0.0254 - 0.066$$

### NOTE:

- The dimensions in the table above and the values obtained from the above formulas may contain slight errors.
- If you use the projection distance for the 16:9 screen, the 4:3 projection image overflows the screen at the top and bottom.

- If you set up the projector vertically, it may cause to damage the projector.
- It is recommended that you set up the projector in a place that is tilted at less than  $\pm 30^\circ$ . Setting up the projector in places that are tilted at more than  $\pm 30^\circ$  may cause malfunctions.

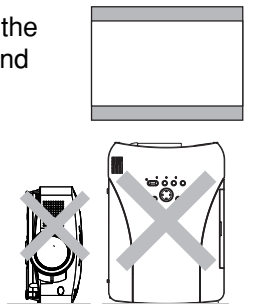

# Starting to use

## Turning on the power

Please ensure that all preparations have been completed before turning on the power. (Refer to pages 21 – 25.)

### ① Remove the lens cover.

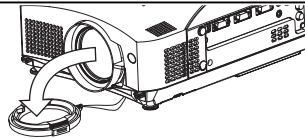

### ② Connect the accessory power cord.

### ③ Press the MAIN POWER switch to the “I” side to turn on the power.

The power indicator on the projector will illuminate red.

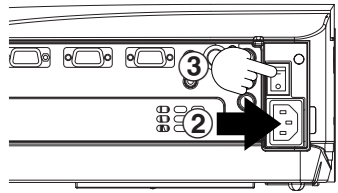

### ④ Press the POWER button.

The power indicator on the projector will flash green. After a short period, the indicator will illuminate green, and a picture will be projected.

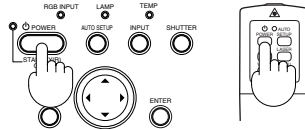

### ⑤ Press the input select (INPUT, RGB, VIDEO) button to select the input signal.

The input signal selected will change as shown at below each time an input select button is pressed.

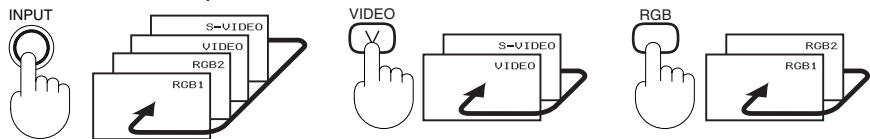
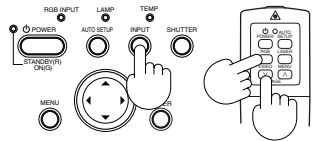

### ⑥ While pressing the adjuster buttons, adjust the forward/back angle of tilt of the projector.

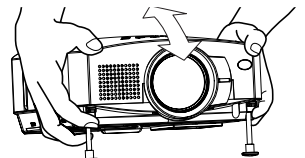

### ⑦ Press the AUTO SETUP button to initiate automatic positioning.

If keystone distortion has not been corrected to the optimum level, carry out keystone correction as described on page 33.

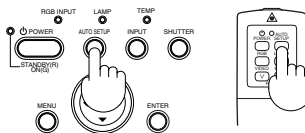

### ⑧ Turn the focus ring and the zoom knob to adjust the projected image focus and size.

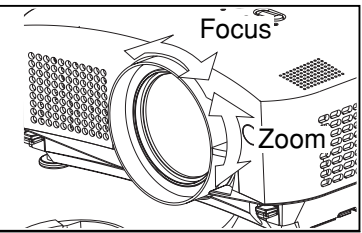

## Turning off the power

### ① Press the POWER button. “POWER OFF” is displayed on the screen.

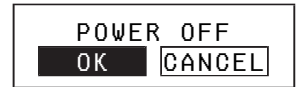

### ② Select “OK” using the ◀ and ▶ buttons and press the ENTER button.

The lamp unit will switch off and the picture will stop being projected. (The power indicator on the projector will illuminate orange.)

### ③ Wait until the power indicator on the projector illuminates red (until the cooling fan stops).

Do not in any way cut power to the projector while the cooling fan is still operating. Be careful not to switch off the MAIN POWER switch of the projector, unplug the power cord from the electrical outlet or turn off in-line switches such as tabletop power switches.

### ④ Press the MAIN POWER switch to the “O” side to turn off the power.

#### NOTE:

- After the power is turned off, the lamp unit will take some time to cool down. If you turn the power back on again before the lamp unit has cooled down, the lamp unit may not turn on straight away, but it will turn on automatically after a short period. (During this time, the power indicator on the projector will flash orange.)
- When the projector is in standby mode (the power indicator on the projector is illuminated red), the projector will still draw a maximum 1.7 W of power, even when the cooling fan has stopped.
- If the MAIN POWER switch is accidentally turned off while the projector is being used, the lamp unit may not turn on straight away after the power is turned back on. In such cases, the lamp unit will turn back on automatically after a short period. (During this time, the power indicator on the projector will flash green.)
- A tinkling sound may be heard while the power indicator is turned off, but this is not a sign of a malfunction.
- You can also turn off the power by pressing the POWER button twice or by holding down it for at least 0.5 seconds.

# On-screen menus

## Menu screens

The various settings and adjustments for this projector can be carried out by selecting the operations from on-screen menus.

The general arrangement of these menus is shown below.

### MAIN MENU

MENU	
KEYSTONE	▶
PICTURE	▶
POSITION	▶
INDEX WINDOW	▶
SHUTTER	▶
AUDIO	▶
LANGUAGE	▶
OPTION1	▶
OPTION2	▶
◀ SELECT [ENTER] ENTER	

### OPTION2 menu (page 40)

OPTION2	
BACK COLOR	◀ BLUE ▶
FRONT/REAR	◀ FRONT ▶
DESK/CEILING	◀ DESK ▶
FAN CONTROL	◀ STANDARD ▶
LAMP POWER	◀ HIGH ▶
LAMP RUNTIME	10H
FUNC 1	◀ INDEX ▶
CONTROL KEY	◀ ON ▶
◀ SELECT [ENTER] ADJ [MENU] ESC	

### OPTION1 menu (page 40)

OPTION1	
OSD	◀ ON ▶
AUTO KEYSTN	◀ ON ▶
AUTO RGB IN	◀ ON ▶
RGB2 SELECT	◀ INPUT ▶
RGB/Y·PB·PR	◀ Y·PB·PR ▶
SXGA MODE	◀ SXGA ▶
◀ SELECT [ENTER] ADJ [MENU] ESC	

▶ **Keystone correction**  
(page 33)

▶ **INDEX WINDOW function**  
(page 43)

▶ **SHUTTER function**  
(page 42)

▶ **Volume adjustment**  
Press the ENTER button, and then press the ◀ and ▶ buttons to adjust the volume.

### ▶ LANGUAGE menu (page 42)

LANGUAGE		ENGLISH
ENGLISH		
DEUTSCH		
FRANÇAIS		
ESPAÑOL		
ITALIANO		
日本語		
中文		
◀ SELECT [ENTER] ENTER [MENU] ESC		

▶ **PICTURE menu** (page 34)  
When an RGB signal is being input

PICTURE	
PICTURE MODE ◀ STANDARD ▶	
COLOR TEMP. ◀ STANDARD ▶	
BRIGHT	32
CONTRAST	32
SHARPNESS	0
W-BAL R	32
W-BAL G	32
W-BAL B	32
SIGNAL MODE SVGA	
STANDARD	
◀ SELECT [ENTER] ADJ [MENU] ESC	

### NOTE:

- Noise Reduction (NR) is only for PT-L720U.

▶ **POSITION menu** (page 37)  
When an RGB/YPbPr signal is being input

POSITION	
H-POSITION	64
V-POSITION	32
DOT CLOCK	32
CLOCK PHASE	16
ASPECT	◀ 4:3 ▶
RESIZING	◀ ON ▶
STANDARD	
◀ SELECT [ENTER] ENTER [MENU] ESC	

When a YPbPr signal is being input

PICTURE	
PICTURE MODE ◀ STANDARD ▶	
COLOR TEMP. ◀ STANDARD ▶	
COLOR	32
TINT	32
BRIGHT	32
CONTRAST	32
SHARPNESS	2
NR	1
SIGNAL MODE 525I	
STANDARD	
◀ SELECT [ENTER] ADJ [MENU] ESC	

When an S-VIDEO/VIDEO signal is being input

PICTURE	
PICTURE MODE ◀ STANDARD ▶	
COLOR TEMP. ◀ STANDARD ▶	
COLOR	32
TINT	32
BRIGHT	32
CONTRAST	32
SHARPNESS	2
NR	1
TV-SYSTEM ◀ AUTO1 ▶	
STANDARD	
◀ SELECT [ENTER] ADJ [MENU] ESC	

When an S-VIDEO/VIDEO signal is being input

POSITION	
H-POSITION	32
V-POSITION	16
ASPECT	◀ 4:3 ▶
RESIZING	◀ ON ▶
STANDARD	
◀ SELECT [ENTER] ENTER [MENU] ESC	

### NOTE:

- Keystone distortion of the on-screen display will not be corrected.

## Menu operation guide

### ① Press the MENU button.

The MAIN MENU screen will be displayed.

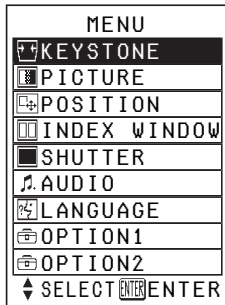

### ② Press the ▲ or ▼ arrow buttons to select an item.

Selected items will be displayed in blue.

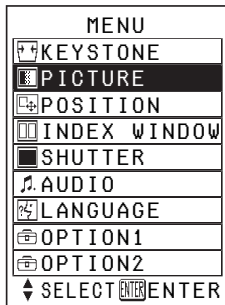

### ③ Press the ENTER button to accept the selection.

The selected menu screen or adjustment screen will then be displayed.

(Example: PICTURE menu)

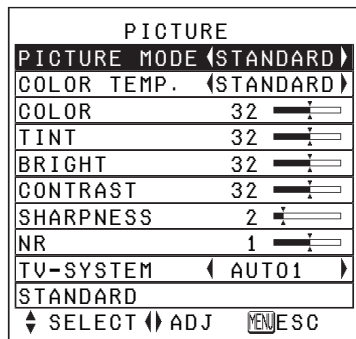

### ④ Press the ▲ or ▼ buttons to select an item, and then press the ◀ or ▶ buttons to change or adjust the setting.

An individual adjustment screen such as the one shown below will be displayed for bar-scale items.



The bar scale will turn green when any adjustment changes the setting from the factory set value.

## Unavailable on-screen menu items

This projector has unadjustable items and unusable functions depending on the signal being input. When an item cannot be adjusted or a function cannot be used, the corresponding on-screen menu display does not appear, and the item or function will not work even if the ENTER button is pressed.

## Returning to the previous screen

If you press the MENU button while a menu screen is being displayed, the display will return to the previous screen.

If you press the MENU button while the MAIN MENU screen is being displayed, the MAIN MENU screen will be cleared.

## Returning a setting to the factory default

If you press the STD (standard) button on the remote control unit, you can return settings to the factory default settings. However, the operation of this function varies depending on which screen is being displayed.

- When a menu screen is being displayed

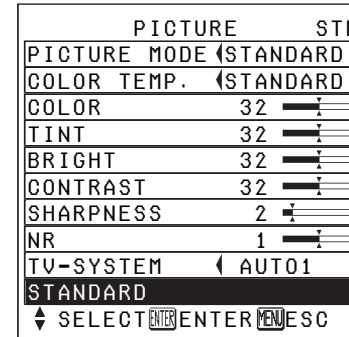

All items displayed will be returned to their factory default settings, "STD" will be displayed in the top-right screen and the bar scale will appear white.

### NOTE:

- You can also select STANDARD from the menu screen and then press the ENTER button.

## Using the freeze function

The picture will alternate between a still picture and a moving picture each time the FREEZE button on the remote control unit is pressed.

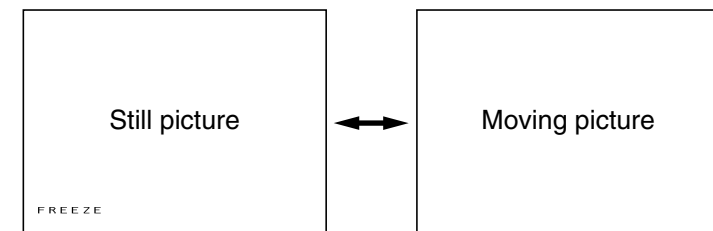

- When an individual adjustment screen is being displayed



Only the item displayed will be returned to the factory default setting, and the bar scale will appear white.

### NOTE:

- Triangle symbols above and below a menu bar indicate the factory default setting. Items which do not have these triangle symbols cannot be returned to the factory default setting.

Indicates the standard factory default setting

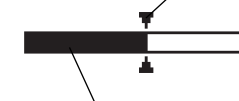

Indicates the current adjustment value

- The positions of triangle symbols vary depending on the type of signal being input.



# Using the D.ZOOM (digital zoom) function

This function lets you enlarge the picture.

① Press a D.ZOOM +/- button

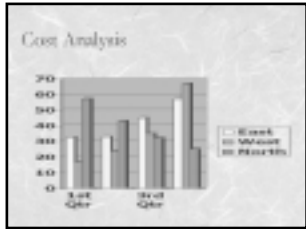

The picture will then be enlarged to 1.5 times the normal size.

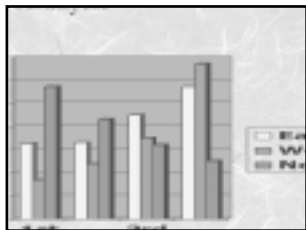

② Use the ▲, ▼, ◀ and ▶ buttons to move the enlarged area which you want to project.

③ Use the D.ZOOM +/- buttons to change the enlargement ratio. The enlargement ratio can be changed within the range of x1 to x2, in steps of 0.1.

**NOTE:**

- When RGB signals are being input, the enlargement ratio can be changed within the range of x1 to x3.

④ Press the MENU button to return to the normal screen.

**NOTE:**

- This function can only be used when using the remote control unit.
- If the type of signal being input changes while the digital zoom function is being used, the digital zoom function will be cancelled.

# Correcting keystone distortion

Keystone distortion is corrected automatically when the projector's automatic setup function is used, but this correction will not apply if the screen itself is tilted. In such cases, you can correct the keystone distortion manually with the following procedure.

- ① Select "KEYSTONE" from the MAIN MENU screen, and then press the ENTER button.
- ② Press the ◀ or ▶ buttons to correct the keystone distortion.

Picture condition	Operation
	Press the ▶ button.
	Press the ◀ button.

③ Press the MENU button to return to the previous screen.

**NOTE:**

- If you press the AUTO SETUP button after correcting the keystone distortion manually, the automatic keystone correction function will operate and the corrected picture will return to its previous incorrect condition. To prevent this from happening, you can set "AUTO KEYSTN" in the OPTION1 menu to "OFF".
- Keystone distortion can be corrected to  $\pm 30^\circ$  of the angle of tilt for the projector. However, the greater the correction amount, the more the picture quality will deteriorate, and the harder it will become to achieve a good level of focus. To obtain the best picture quality, set up the projector and screen in such a way that the amount of keystone correction required is as minimal as possible.
- The picture size will also change when correction of keystone distortion is carried out.

# Adjusting the picture

Use the ▲ and ▼ buttons on the projector or remote control unit to select an item, and then use the ◀ and ▶ buttons to change the setting for that item.

For items with bar scales, press the ENTER button or the ◀ or ▶ buttons to display the adjustment screen, and then use the ◀ or ▶ buttons to make the adjustment.

When an RGB signal is being input

PICTURE	
PICTURE MODE	◀STANDARD▶
COLOR TEMP.	◀STANDARD▶
BRIGHT	32
CONTRAST	32
SHARPNESS	0
W-BAL R	32
W-BAL G	32
W-BAL B	32
SIGNAL MODE	SVGA
STANDARD	
◀ SELECT ▶ ADJ	

When an YPbPr signal is being input

PICTURE	
PICTURE MODE	◀STANDARD▶
COLOR TEMP.	◀STANDARD▶
COLOR	32
TINT	32
BRIGHT	32
CONTRAST	32
SHARPNESS	2
NR	1
SIGNAL MODE	525I
STANDARD	
◀ SELECT ▶ ADJ	

When an S-VIDEO/VIDEO signal is being input

PICTURE	
PICTURE MODE	◀STANDARD▶
COLOR TEMP.	◀STANDARD▶
COLOR	32
TINT	32
BRIGHT	32
CONTRAST	32
SHARPNESS	2
NR	1
TV-SYSTEM	◀AUTO1▶
STANDARD	
◀ SELECT ▶ ADJ	

## PICTURE MODE

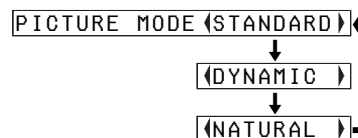

Select the picture mode that best matches the image source and room conditions.

The mode best used in dark rooms is NATURAL. For rooms having regular lighting conditions in use, select STANDARD. For exceptionally bright rooms, use DYNAMIC.

## Color Hue Setting (color temperature)

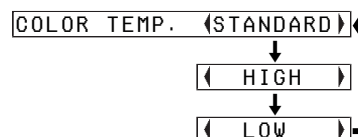

This is used to adjust the white areas of the picture if they appear bluish or reddish.

## COLOR

(S-VIDEO/VIDEO/YPbPr only)

Press the ▶ button to make the color more vivid in tone, and press the ◀ button to make the color more pastel in tone.

## TINT

(NTSC/NTSC 4.43/YPbPr only)

This adjusts the flesh tones in the picture. Press the ▶ button to make flesh tones more greenish, and press the ◀ button to make the flesh tones more reddish.

## BRIGHT

This adjusts the darker areas (black areas) in the picture. Press the ▶ button if dark areas are too solid (for example, if hair is difficult to see), and press the ◀ button if black areas are too light (grey rather than black).

## CONTRAST

This adjusts the contrast of the picture. Press the ▶ button to make the picture brighter, and press the ◀ button to make the picture darker. (Adjust the BRIGHT setting first if required before adjusting the CONTRAST setting.)

## SHARPNESS

Press the ▶ button to make the picture details sharper, and press the ◀ button to make the picture details softer.

## Noise Reduction (NR)

(Only for PT-L720U, when S-VIDEO/VIDEO/YPbPr signals are being input)

If the signal is of such poor quality that picture interference appears, you can suppress this interference by adjusting the NR (Noise Reduction), except for 750p (720p), HDTV60

(1080i/60) and HDTV50 (1080i/50) signals. To strengthen the effect, press the ▶ button. To turn it off, set to "0" by pressing the ◀ button.

## TV SYSTEM

(S-VIDEO/VIDEO only)

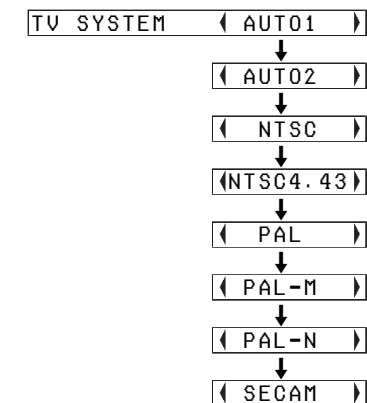

**AUTO1** The projector automatically distinguishes between NTSC/NTSC 4.43/PAL/PAL60/SECAM signals.

**AUTO2** The projector automatically distinguishes between NTSC/PAL-M/PAL-N signals.

### NOTE:

- This should normally be set to "AUTO1" or "AUTO2". If the signal is of such poor quality that the correct format cannot be automatically distinguished, change the setting manually to the required TV system.

## WHITE BALANCE R/G/B

(RGB only)

This is used to adjust the white areas of the picture if they appear coloured. Press the ◀ button to make the selected color lighter. Press the ▶ button to make the selected color stronger.

## SIGNAL MODE

(RGB/YPbPr only)

This displays the type of signal which is currently being projected. Refer to the table on page 56 for details on each type of signal.

## Projecting sRGB-compatible pictures

sRGB is an international color reproduction standard (IEC61966-2-1) established by the International Electrotechnical Commission (IEC). If you would like the colors in sRGB-compatible pictures to be reproduced more faithfully, make the following settings.

- 1 Press the ▲ or ▼ button to select "PICTURE MODE", and then use the ◀ or ▶ button to select "NATURAL".
- 2 Press the STANDARD (STD) button on the remote control unit.
- 3 Press the ▲ or ▼ button to select "COLOR TEMP.", and then use the ◀ or ▶ button to select "STANDARD".

### NOTE:

- sRGB is only enabled when RGB signals are being input (when LAMP POWER has been set to "HIGH").

## Adjusting the position

When the input signal is RGB, first press the AUTO SETUP button to initiate automatic positioning. If the optimum setting is not obtained when AUTO SETUP is carried out, adjust by the following procedure.

Use the ▲ and ▼ buttons on the projector or remote control unit to select an item, and then use the ◀ and ▶ buttons to change the setting for that item.

For items with bar scales, press the ENTER button or the ◀ or ▶ buttons to display the adjustment screen, and then use the ◀ or ▶ buttons to make the adjustment.

When an RGB/YPbPr signal is being input

POSITION	
H-POSITION	64
V-POSITION	32
DOT CLOCK	32
CLOCK PHASE	16
ASPECT	4:3
RESIZING	ON
STANDARD	
◆ SELECT ENTER ENTER MENU ESC	

When an S-VIDEO/VIDEO signal is being input

POSITION	
H-POSITION	32
V-POSITION	16
ASPECT	4:3
RESIZING	ON
STANDARD	
◆ SELECT ENTER ENTER MENU ESC	

## HORIZONTAL POSITION

Press the ◀ button to move the picture to the left, and press the ▶ button to move the picture to the right.

## VERTICAL POSITION

Press the ◀ button to move the picture down, and press the ▶ button to move the picture up.

## DOT CLOCK

(RGB only)

Periodic striped pattern interference (noise) may occur when a striped pattern such as the one below is projected. If this happens, use the ◀ and ▶ buttons to adjust so that any such noise is minimised.

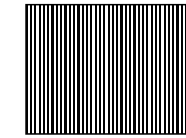

## CLOCK PHASE

(RGB/YPbPr only)

Adjust the DOT CLOCK setting first before carrying out this adjustment. Use the ◀ and ▶ buttons to adjust so that the noise level is least noticeable.

### NOTE:

- If signals with a dot clock frequency of 100 MHz or higher are being input, interference may not be completely eliminated when the DOT CLOCK and CLOCK PHASE adjustments are carried out.

## ASPECT

This setting is only for an S-VIDEO/VIDEO signal and a YPbPr signal in 525i (480i), 525p (480p) and 625i format.

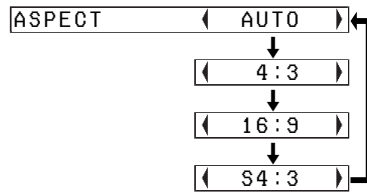

### AUTO

(S-VIDEO only)

When an S1 video signal is input to the S-VIDEO terminal, the aspect ratio is changed automatically to project a 16:9 picture.

### 4:3

The input signal is projected without change.

### 16:9

The picture is compressed to a ratio of 16:9 and projected.

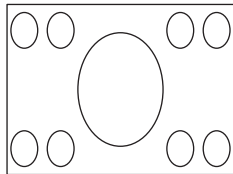

When a squeezed signal is being input. (The projected image is contracted horizontally)

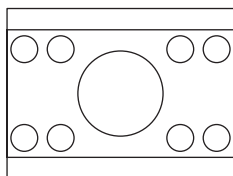

### S4:3

The size of the input signal is compressed to 75% and projected. (This is useful for projecting a picture with a 4:3 aspect ratio onto a 16:9 screen.)

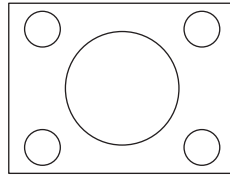

When a 4:3 signal is being input

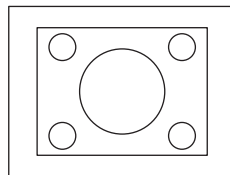

### S1 video signals

- S1 video signals are a type of video signal with an aspect ratio of 16:9 which include a detector signal. This detector signal is output by some sources such as wide-vision video decks. If the AUTO setting above is selected, this projector will recognise the detector signal and automatically switch the aspect ratio to 16:9 in order to project the picture.

### NOTE:

- This projector is equipped with an aspect ratio selection function. However, if a mode which does not match the aspect ratio of the input signal is selected, it may affect the quality of viewing of the original picture. Keep this in mind when selecting the aspect ratio.
- If using this projector in places such as cafes or hotels with the aim of displaying programs for viewing for a commercial purpose or for public presentation, note that if the aspect ratio (16:9) selection function is used to change the aspect ratio of the screen picture, you may be infringing the rights of the original copyright owner for that program under copyright protection laws.
- If a normal (4:3) picture which was not originally intended for wide-screen viewing is projected onto a wide screen, distortion may occur around the edges of the picture so that part of the picture is no longer visible. Such programs should be viewed in 4:3 mode to give proper consideration to the aims and intentions of the original program's creator.

## RESIZING

This should normally be set to "ON". (This setting is only for signals which have lower resolutions than the LCD panels. Refer to page 56 for details.)

### ON

The pixel resolution of the input signal is converted to the same resolution as the LCD panels before being projected. For signals with lower resolutions, gaps in the pixels are automatically interpolated into the picture before it is projected. This may sometimes cause problems with the quality of the picture.

### OFF

The picture signal is projected at its original resolution, with no pixel conversion. The projected picture will be smaller than normal, so adjust the zoom setting or move the projector forwards or backwards to adjust the picture size if necessary. If set to "OFF", some features, such as D.ZOOM (digital zoom), keystone distortion correction or INDEX WINDOW will not function.

# Option settings

Use the ▲ and ▼ buttons on the projector or remote control unit to select an item, then press the ◀ or ▶ buttons to change the setting.

OPTION1	
OSD	◀ ON ▶
AUTO KEYSTN	◀ ON ▶
AUTO RGB IN	◀ ON ▶
RGB2 SELECT	◀ INPUT ▶
RGB/Y·PB·PR	◀ Y·PB·PR ▶
SXGA MODE	◀ SXGA ▶
◆ SELECT	◆ ADJ

OPTION2	
BACK COLOR	◀ BLUE ▶
FRONT/REAR	◀ FRONT ▶
DESK/CEILING	◀ DESK ▶
FAN CONTROL	◀ STANDARD ▶
LAMP POWER	◀ HIGH ▶
LAMP RUNTIME	10H
FUNC 1	◀ INDEX ▶
CONTROL KEY	◀ ON ▶
◆ SELECT	◆ ADJ

## OSD

### ON

The current input name is displayed in the top-right corner of the screen when the input signal is changed.

### OFF

Use this setting when you do not want the current input name to be displayed.

## AUTO KEYSTN

This should normally be set to ON.

### ON

During automatic setup, the angle of tilt of the projector is detected and keystone distortion is corrected automatically.

### OFF

Use this setting when you do not want automatic keystone correction

to be carried out during automatic setup, such as when the screen itself is at an angle.

## AUTO RGB IN

This should normally be set to ON.

### ON

During automatic setup, the projector selects whichever one of the RGB1 IN or RGB2 IN connectors has a signal being input, and uses that signal for projection. (If a picture is being projected, the signal source is not automatically changed.)

### OFF

Use this setting when you do not want the signal source to be changed automatically during automatic setup.

## RGB2 SELECT

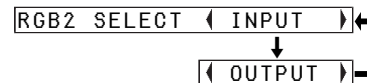

This setting is used to select the function of the RGB2 IN/RGB1 OUT connector.

## RGB/Y·PB·PR

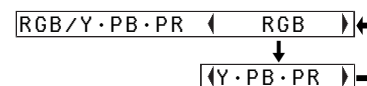

This setting is valid when HDTV, 525p (480p) and some VGA480 signals are being input. Select the setting in accordance with the input signal.

## SXGA MODE

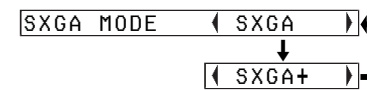

This setting is only for an SXGA signal.

### SXGA

Select this item normally.

### SXGA+

When the projected image is contracted vertically, select this item.

## BACK COLOR

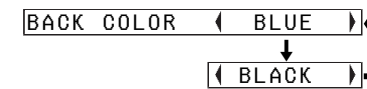

This sets the color which is projected onto the screen when no signal is being input to the projector.

## FRONT/REAR

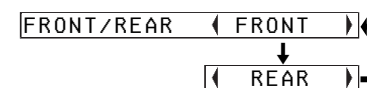

This setting should be changed in accordance with the projector setting-up method. Set to "FRONT" when using a normal reflective screen with the projector positioned in front of the screen, and set to "REAR" when using a translucent screen with the projector positioned behind the screen.

## DESK/CEILING

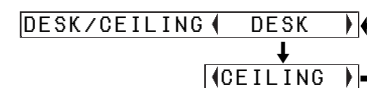

This setting should be changed in accordance with the projector setting-up method. Set to "DESK" when setting up the projector on a desk or similar, and set to "CEILING" when suspending

the projector from the ceiling using the ceiling bracket which is sold separately.

## FAN CONTROL

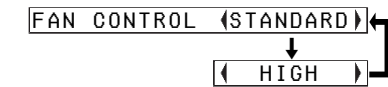

If using of this projector at high elevations (above 1400 m), set FAN CONTROL to "HIGH".

## LAMP POWER

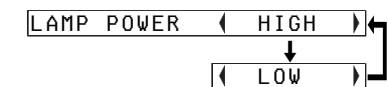

This setting changes the lamp brightness. When set to "LOW", the luminance of the lamp is reduced, but the projector uses less power, and the operating noise is also reduced. This can help to extend the lamp's operating life. If using the projector in small rooms where high luminance is not required, it is recommended that you set the LAMP POWER to "LOW".

## LAMP RUNTIME

This setting displays the usage time for the lamp unit which is currently being used.

### NOTE:

- The lamp's operating life varies depending on the usage conditions (such as the LAMP POWER setting and the number of times the power is turned on and off).

## FUNC 1

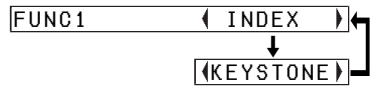

This assigns a function to the FUNC1 button of the remote control unit .

### INDEX

- Functions in the same way as the INDEX WINDOW function. (page 43)

### KEYSTONE

- Functions in the same way as when “KEYSTONE” is selected from the MAIN MENU screen. (page 33)

## CONTROL KEY

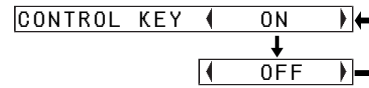

To make the buttons on the projector not function, set CONTROL KEY to OFF.

To use the buttons on the projector, set to ON. (page 14)

## Using the shutter function

The shutter function can be used to momentarily turn off the picture and sound from the projector when the projector is not being used for short periods of time, such as during breaks in meetings or when carrying out preparation. The projector uses less power in shutter mode than it does in normal projection mode.

### ① Press the SHUTTER button on the remote control unit.

You can also select SHUTTER from the MAIN MENU screen and then press the ENTER button.

### ② Press any button on either the projector or remote control unit to return to normal operating mode.

## Changing the display language

Use the ▲ and ▼ buttons on the projector or remote control unit to select a language, then press the ENTER button to accept the setting.

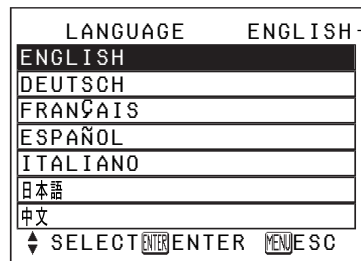

Indicates the language which is currently set

## Using the INDEX WINDOW function

This function lets you store a picture which is being projected into memory, so that you can display a still picture and a moving picture on the screen.

Select INDEX from the FUNC1 item in the OPTION2 menu to use this function. (Refer to page 42.)

### ① Press the FUNC1 button.

You can also select INDEX WINDOW from the MAIN MENU screen and then press the ENTER button.

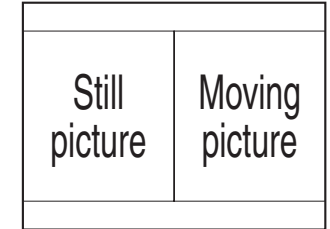

### NOTE:

- The aspect ratio of the screen changes and the image is vertically elongated in comparison to a normal image.

### ② Use the ▲ and ▼ buttons to select a screen size.

When the screen size is changed, the picture's aspect ratio will also change.

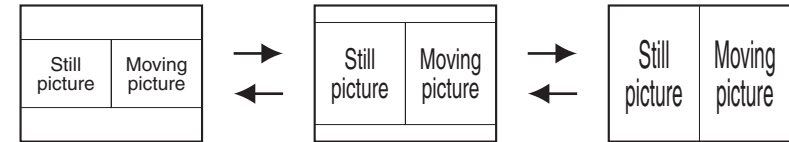

### NOTE:

- Make sure that you fully understand the notes on ASPECT which are given on page 38 before using the index window function.
- ③ Use the ◀ and ▶ buttons to switch between the still picture screen and moving picture screen.

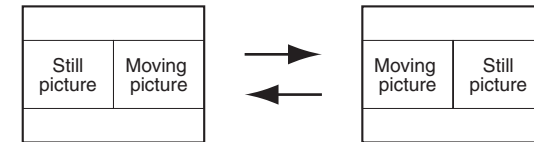

### ④ Press the ENTER button to capture the present moving picture in a still window.

### NOTE:

- When steps ② and ③ are carried out, the present moving picture will be captured in a still window also.
- When the input signal is changed, this function will be cancelled.

# Using the SERIAL connector

The serial connector which is on the side connector panel of the projector conforms to the RS-232C interface specification, so that the projector can be controlled by a personal computer which is connected to this connector.

## Connection

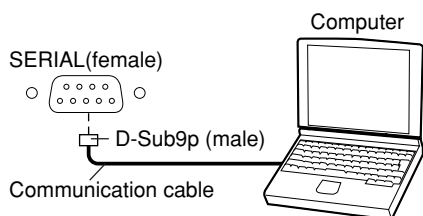

### NOTE:

- Use a proper communication cable which is suitable for the personal computer to connect the serial connector and the personal computer.

## Pin layout and signal names for SERIAL connector

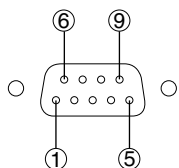

D-SUB 9-pin connector seen from outside

Pin No.	Signal name	Contents
①		NC
②	TXD	Transmitted data
③	RXD	Received data
④		NC
⑤	GND	
⑥	DSR	Connected internally
⑦	CTS	
⑧	RTS	
⑨		NC

## Communications settings

Signal level	RS-232C
Sync. method	Asynchronous
Baud rate	9 600 bps
Parity	None
Character length	8 bits
Stop bit	1 bit
X parameter	None
S parameter	None

## Basic format

The data sent from the computer to the projector is transmitted in the format shown below.

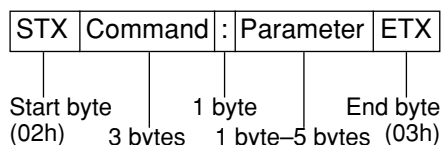

### NOTE:

- The projector can not receive the command for 10 seconds after the lamp is switched on. Wait 10 seconds before sending the command.
- If sending multiple commands, check that a response has been received from the projector for one command before sending the next command.
- When a command which does not require parameters is sent, the colon (:) is not required.
- If an incorrect command is sent from the personal computer, the “ER401” command will be sent from the projector to the personal computer.

## Control commands

The commands which the personal computer can use to control the projector are shown in the following table.

Command	Control Contents	Remarks
PON	Power ON	In standby mode, all commands other than the PON command are ignored. <ul style="list-style-type: none"> <li>• The PON command is ignored during lamp ON control.</li> <li>• If a PON command is received while the cooling fan is operating after the lamp has switched off, the lamp is not turned back on again straight away, in order to protect the lamp.</li> </ul>
POF	Power OFF	
AVL	Volume	Parameter 000–063(Adjustment value 0–63)
IIS	Input signal selection	Parameter VID=VIDEO SVD=S-VIDEO RG1=RGB1(YPBPR1) RG2=RGB2(YPBPR2)
Q\$S	Lamp ON condition query	Parameter 0 = Standby 1 = Lamp ON control active 2 = Lamp ON 3 = Lamp OFF control active

## Cable specifications

(When connected to a personal computer)

At the projector

1	NC
2	
3	
4	NC
5	
6	NC
7	
8	
9	NC

At the computer (DTE specifications)

NC	1
	2
	3
NC	4
	5
NC	6
	7
	8
NC	9

# Indicators

There are two indicators on the control panel of the projector which give information about the operating condition of the projector. These indicators illuminate or flash to warn you about problems that have occurred inside the projector, so if you notice that one of the indicators is on, turn off the power and check the table below for the cause of the problem.

TEMP indicator			
Indicator display	Illuminated (red) (Lamp unit on)	Flashing (red) (Lamp unit on)	Flashing (red) (Lamp unit off)
<b>Problem</b>	The surrounding temperature or the temperature inside the projector has become unusually high.	The temperature inside the projector has become dangerously high, or the temperature has suddenly changed.	The surrounding temperature or the temperature inside the projector has become dangerously high, causing the lamp unit to be automatically shut off.
<b>Possible cause</b>	<ul style="list-style-type: none"> <li>• The ventilation holes may be covered.</li> <li>• The ambient temperature in the place of use may be too high.</li> <li>• The air filter may be blocked.</li> </ul>		
<b>Remedy</b>	<ul style="list-style-type: none"> <li>• Uncover the ventilation holes.</li> <li>• Set up the projector in a place where the temperature is between 0 °C (32 °F) and 40 °C (104 °F) and the humidity is between 20% and 80% (with no condensation). [If you set the FAN CONTROL to "HIGH" (page 41), set up the projector in a place where the temperature is between 0 °C (32 °F) and 35 °C (95 °F) and the humidity is between 20% and 80% (with no condensation).]</li> <li>• Turn off the MAIN POWER switch by following the procedure on page 27, and then clean the air filter (refer to page 48).</li> </ul>		

LAMP indicator			
Indicator display	Illuminated (red)	Flashing (red)	
<b>Problem</b>	It is nearly time to replace the lamp unit.	An abnormality has been detected in the lamp circuit.	
<b>Possible cause</b>	<ul style="list-style-type: none"> <li>• Does "REPLACE LAMP" appear on the screen after the projector is turned on?</li> </ul>	<ul style="list-style-type: none"> <li>• The power may have been turned on straight away after it was turned off.</li> </ul>	<ul style="list-style-type: none"> <li>• There may be an abnormality in the lamp circuit.</li> </ul>
<b>Remedy</b>	<ul style="list-style-type: none"> <li>• This occurs when the operation time for the lamp unit is nearing 1 800 hours. (when LAMP POWER has been set to "HIGH") Ask your dealer or an Authorised Service Center to replace the lamp unit.</li> </ul>	<ul style="list-style-type: none"> <li>• Wait for a while until the lamp unit cools down before turning the power back on again.</li> </ul>	<ul style="list-style-type: none"> <li>• Turn off the MAIN POWER switch by following the procedure given on page 27, and then contact an Authorised Service Center.</li> </ul>

**NOTE:**

- Be sure to turn off the MAIN POWER switch by following the procedure given in "Turning off the power" on page 27 before carrying out any of the procedures in the "Remedy" column.
- If the main power turns off after the TEMP indicator starts flashing, it means that an abnormality has occurred. Please contact an Authorised Service Center so that the necessary repairs can be made.



# Cleaning and replacing the air filter

If the air filter becomes clogged with dust, the internal temperature of the projector will rise, the TEMP indicator will flash and the projector power will turn off. **The air filter should be cleaned every 100 hours of use,** depending on the location where the projector is being used.

## Cleaning procedure

- ① **Turn off the MAIN POWER switch and disconnect the power cord plug from the wall outlet.**

Turn off the MAIN POWER switch according to the procedure given in "Turning off the power" on page 27 before disconnecting the plug from the wall outlet.

- ② **Gently turn the projector upside down.**

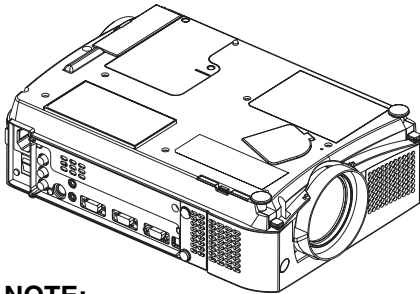

### NOTE:

- Place the projector on top of a soft cloth so that it will not become scratched.

- ③ **Remove the air filter.**

Put your fingernails under the air filter and pull the air filter out of the projector.

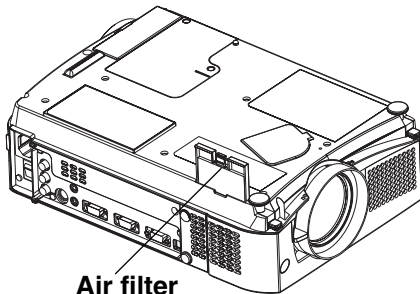

- ④ **Clean the air filter.**

Use a vacuum cleaner to clean off any accumulated dust.

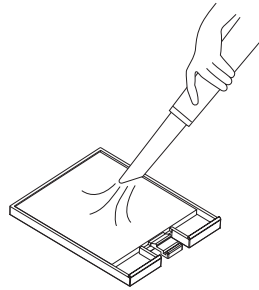

### NOTE:

- Be careful not to let the air filter get sucked into the vacuum cleaner.

- ⑤ **Install the air filter.**

### NOTE:

- Be sure to install the air filter cover before using the projector. If the projector is used without the air filter cover installed, dust and other foreign particles will be drawn into the projector, and malfunctions will result.
- If the dust cannot be removed by cleaning, it is time to replace the air filter. Please consult your dealer. Furthermore, if the lamp unit is being replaced, replace the air filter at this time also.

# Replacing the lamp unit

## Warning

**When replacing the lamp, allow it to cool for at least one hour before handling it.**

- The lamp cover gets very hot, and contact with it can cause burns.

## Notes on replacing the lamp unit

- The light generating lamp is made of glass, so dropping it or allowing it to hit hard objects may cause it to burst. Be careful when handling the lamp.
- After having removed the old lamp, carelessly discarding it can cause the lamp to burst. Dispose of the lamp with the same care that would be taken with a fluorescent light.
- A Phillips screwdriver is necessary for removing the lamp unit. Make sure that your hands are not slippery when using the screwdriver.

### NOTE:

- The projector is not supplied with a replacement lamp unit. Please ask your dealer for details. Lamp unit product no.: **ET-LA730**

### CAUTION:

- Do not use any lamp unit other than the one with the product number indicated above.

## Lamp unit replacement period



The lamp is a consumable product. Even when the full life of the bulb has not been exhausted, the brightness of the light will gradually decline. Therefore periodic replacement of the lamp is necessary.

The intended lamp replacement interval is 2 000 hours, but it is possible that the lamp may need to be replaced earlier due to variables such as a particular lamp's characteristics, usage conditions and the installation environment. Early preparation for lamp replacement is encouraged.

A lamp that has exceeded 2 000 hours of use has a much greater chance of exploding. In order to prevent the lamp from exploding, the lamp will be automatically shut off when 2 000 hours of use have been reached.

### NOTE:

- The usage hours explained above are for use when the HIGH setting has been selected for LAMP POWER in the OPTION2 menu. If the LOW setting is selected, the brightness of the lamp will be less and life of the lamp can be extended.
- While 2 000 hours is the intended replacement interval, it is not a period of time covered by warranty.

	On-screen display 	Lamp indicator warning light 
More than 1 800 hours	Displayed for 30 seconds. Pressing any button will clear the display.	The projector will enter Standby Mode and the red indicator lamp will illuminate.
More than 2 000 hours	This display cannot be cleared at all, no matter which button is pressed.	

## Lamp unit replacement procedure

### NOTE:

- If the lamp usage time has passed 2 000 hours (when LAMP POWER has been set to “HIGH”), the projector will switch to standby mode after approximately 10 minutes of operation. The steps ⑦ to ⑪ on the next page should thus be completed within 10 minutes.

- ① Turn off the MAIN POWER switch according to the procedure given in “Turning off the power” on page 27, and then disconnect the power cord plug from the wall outlet and check that the area around the lamp unit has cooled down.
- ② Use a Phillips screwdriver to turn the lamp unit cover fixing screws at the bottom of the projector, and then remove the lamp unit cover from the projector.

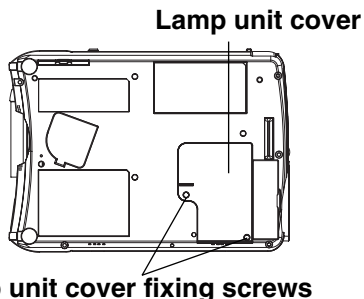

- ③ Use a Phillips screwdriver to loosen the two lamp unit fixing screws until the screws turn freely. Then hold the handle of the lamp unit and gently pull it out from the projector.

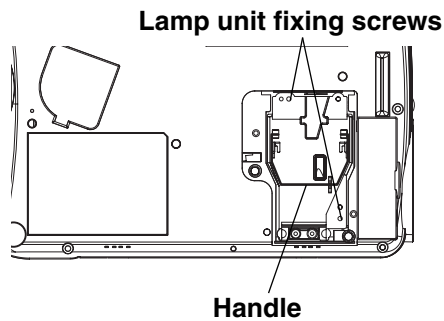

- ④ Insert the new lamp unit while making sure that the direction of insertion is correct, and then use a Phillips screwdriver to securely tighten the lamp unit fixing screws.

- ⑤ Install the lamp unit cover, and then use a Phillips screwdriver to securely tighten the lamp unit cover fixing screws.

### NOTE:

- Be sure to install the lamp unit and the lamp unit cover securely. If they are not securely installed, it may cause the protection circuit to operate so that the power cannot be turned on.

- ⑥ Insert the power cord plug into the wall outlet and then press the MAIN POWER switch.

### NOTE:

- If the POWER indicator on the projector does not illuminate red when the MAIN POWER switch is turned on, turn the MAIN POWER switch off again and check that the lamp unit and the lamp unit cover are securely installed. Then turn the MAIN POWER switch back on.

- ⑦ Press the POWER button so that a picture is projected onto the screen.

- ⑧ Press the MENU button to display the MAIN MENU screen, and then press the ▲ and ▼ buttons to move the cursor to select “OPTION2”.

MENU	
KEYSTONE	
PICTURE	
POSITION	
INDEX WINDOW	
SHUTTER	
AUDIO	
LANGUAGE	
OPTION1	
OPTION2	
SELECT	ENTER

- ⑨ Press the ENTER button to display the OPTION2 screen, and then use the ▲ and ▼ buttons to select LAMP RUNTIME.

OPTION2	
BACK COLOR	BLUE
FRONT/REAR	FRONT
DESK/CEILING	DESK
FAN CONTROL	STANDARD
LAMP POWER	HIGH
LAMP RUNTIME	1820H
FUNG 1	INDEX
CONTROL KEY	ON
SELECT	MENU/ESC

- ⑩ Press and hold the ENTER button for approximately 3 seconds.

OPTION2	
BACK COLOR	BLUE
FRONT/REAR	FRONT
DESK/CEILING	DESK
FAN CONTROL	STANDARD
LAMP POWER	HIGH
TIME RESET [POWER OFF]	
FUNG 1	INDEX
CONTROL KEY	ON
SELECT	MENU/ESC

The “LAMP RUNTIME” will change to “TIME RESET [POWER OFF]”.

### NOTE:

- If the MENU button is pressed, the lamp time resetting screen will be cancelled.

- ⑪ Turn off the power.

This will reset the cumulative usage time for the lamp unit to zero.

Refer to page 27 for details on how to turn off the power.

# Before calling for service

Before calling for service, check the following points.

Problem	Possible cause
<b>Power does not turn on.</b>	<ul style="list-style-type: none"> <li>• The power cord may not be connected.</li> <li>• The MAIN POWER switch is turned off.</li> <li>• The main power supply is not being supplied to the wall outlet.</li> <li>• TEMP indicator is illuminated or flashing. (Refer to page 46.)</li> <li>• LAMP indicator is illuminated or flashing. (Refer to page 47.)</li> <li>• The lamp unit cover has not been securely installed.</li> </ul>
<b>No picture appears.</b>	<ul style="list-style-type: none"> <li>• The video signal input source may not be connected properly.</li> <li>• The input selection setting may not be correct. (Refer to page 26.)</li> <li>• The BRIGHT adjustment setting may be at the minimum possible setting. (Refer to page 35.)</li> <li>• The shutter function may be in use. (Refer to page 42.)</li> </ul>
<b>The picture is fuzzy.</b>	<ul style="list-style-type: none"> <li>• The lens cover may still be attached to the lens.</li> <li>• The lens focus may not have been set correctly. (Refer to page 27.)</li> <li>• The projector may not be at the correct distance from the screen. (Refer to page 25.)</li> <li>• The lens may be dirty.</li> <li>• The projector may be tilted too much. (Refer to page 24.)</li> </ul>
<b>COLOR is too light or TINT is poor.</b>	<ul style="list-style-type: none"> <li>• COLOR or TINT adjustment may be incorrect. (Refer to page 35.)</li> <li>• The input source which is connected to the projector may not be adjusted correctly.</li> </ul>
<b>No sound can be heard.</b>	<ul style="list-style-type: none"> <li>• The audio signal source may not be connected properly.</li> <li>• The volume adjustment may be at the lowest possible setting. (Refer to pages 15 and 28.)</li> <li>• A cable may be connected to the AUDIO OUT jack.</li> </ul>

Problem	Possible cause
<b>The remote control unit does not operate.</b>	<ul style="list-style-type: none"> <li>• The batteries may be weak.</li> <li>• The batteries may not be inserted correctly. (Refer to page 20.)</li> <li>• The remote control signal receptor on the projector may be obstructed. (Refer to page 20.)</li> <li>• The remote control unit may be out of the operation range. (Refer to page 20.)</li> </ul>
<b>The buttons on the projector do not function.</b>	<ul style="list-style-type: none"> <li>• The CONTROL KEY may be set to "OFF". (Refer to page 42) In order to set the CONTROL KEY to "ON" without using the remote control unit, keep holding down the ENTER button on the projector and press the MENU button for more than 2 seconds. It will then be turned ON.</li> </ul>
<b>The picture does not display correctly.</b>	<ul style="list-style-type: none"> <li>• The signal format (TV system) may not be set correctly. (Refer to page 35.)</li> <li>• There may be a problem with the video tape or other signal source.</li> <li>• A signal which is not compatible with the projector may be being input. (Refer to page 56.)</li> </ul>
<b>Picture from computer does not appear.</b>	<ul style="list-style-type: none"> <li>• The cable may be too long.</li> <li>• The external video output for the laptop computer may not be set correctly. (You may be able to change the external output settings by pressing the [Fn]+[F3] or [Fn]+[F10] keys simultaneously. The actual method varies depending on the type of computer, so refer to the documentation provided with your computer for further details.)</li> <li>• If an RGB input indicator (refer to pages 14 and 17) is turned off, the video signals may not be output from the computer.</li> <li>• RGB2 SELECT in the OPTION1 menu is set to OUTPUT when the signals are input to RGB2 IN / RGB1 OUT connector. (Refer to page 40)</li> </ul>

# Specifications

Power supply:	100 V–240 V ~, 50 Hz/60 Hz
Power consumption:	300 W (During standby (when fan is stopped): Approx. 1.7 W) 3.5 A–1.5 A
Amps:	
LCD panel:	
Panel size (diagonal):	0.9 type (22.86 mm)
Aspect ratio:	4:3 (16:9 compatible)
Display method:	3 transparent LCD panels (RGB)
Drive method:	Active matrix method
Pixels:	
PT-L720U:	786 432 (1024 x 768) x 3 panels
PT-L520U:	480 000 (800 x 600) x 3 panels
Lens:	Manual zoom (1 - 1.3) / focus lens F 1.7 - 2.2, f 28.7 mm - 36 mm
Lamp:	UHM lamp (220 W)
Luminosity:	
PT-L720U:	2 200 lm/ANSI
PT-L520U:	2 000 lm/ANSI
Scanning frequency(for RGB signals):	

	PT-L720U	PT-L520U
<b>Horizontal scanning frequency</b>	31 kHz–91 kHz	31 kHz–70 kHz
<b>Vertical scanning frequency</b>	50 Hz–85 Hz	50 Hz–85 Hz
<b>Dot clock frequency</b>	Less than 100 MHz	Less than 100 MHz

YPbPr signals:	525i (480i), 625i, 525p (480p), 750p (720p), HDTV60 (1080i/60), HDTV50 (1080i/50)
Color system:	7 (NTSC/NTSC 4.43/PAL/PAL-M/PAL-N/PAL60/SECAM)
Projection size:	1016 mm - 7620 mm (40" - 300")
Throw distance::	1.2 m - 11.8 m (3'11" - 38'8")
Optical axis shift:	9:1 (fixed)
Screen aspect ratio:	4:3
Installation:	Front/Rear/Ceiling/Desk (Menu selection method)
Speaker:	4 cm x 3 cm oval x 1
Max. useable volume output:	2 W (mono)

Connectors	
RGB IN/OUT:	Dual-line D-SUB HD 15-pin (female) (One-line is available for input and output)
During YPbPr input/output:	
Y:	1.0 V [p-p], 75 Ω
Pb,Pr :	0.7 V [p-p], 75 Ω
During RGB input/output:	
R.G.B.:	0.7 V [p-p], 75 Ω
G.SYNC:	1.0 V [p-p], 75 Ω
HD/SYNC:	TTL high impedance, automatic plus/minus polarity compatible TTL high impedance, automatic plus/minus polarity compatible
VD:	TTL high impedance, automatic plus/minus polarity compatible
AUDIO IN (for RGB):	Single-line 0.5 V [rms] M3 jack (Stereo MINI)
VIDEO IN:	Single-line, RCA pin jack 1.0 V [p-p], 75 Ω
S-VIDEO IN:	Single-line, Mini DIN 4-pin Y 1.0 V [p-p], C 0.286 V [p-p], 75 Ω
AUDIO IN (for S-VIDEO/VIDEO):	0.5 V [rms] RCA pin jack x 2 (L-R)
AUDIO OUT:	Single-line 0.5 V [rms] M3 jack (Stereo MINI) (Monitor output/stereo compatible) 0 V [rms] - 1.0 V [rms] (variable) D-sub 9p (female) RS-232C compatible
Serial connector:	Moulded plastic (ABS/PC)
Cabinet:	
Dimensions:	
Width:	245 mm (9-5/8")
Height:	118 mm (4-5/8")
Length:	341 mm (13-13/32") (without lens cover)
Weight:	3.9 kg (8.6 lbs.)
Operating environment:	
Temperature:	0 °C–40 °C (32 °F–104 °F) [When the FAN CONTROL is set to "HIGH" (page 41); 0 °C–35 °C (32 °F–95 °F)]
Humidity:	20%–80% (no condensation)
Certifications:	UL60950 FCC Class B
<b>&lt;Remote control unit&gt;</b>	
Power supply:	3 V DC (AAA battery x2)
Operating range:	Approx. 7 m (23') (when operated directly in front of signal receptor) 108 g (3.8 ozs.) (including batteries)
Weight:	
Dimensions:	
Width:	33 mm (1-9/32")
Length:	168 mm (6-19/32")
Height:	40 mm (1-9/16")
<b>&lt;Options&gt;</b>	
Ceiling bracket	ET-PK730
Wireless mouse receiver	ET-RMRC1
Wide conversion lens	ET-LEC701

# List of compatible signals

Mode	Display resolution (dots)*1	Scanning frequency		Dot clock frequency (MHz)	Picture quality*2		Resizing*3		Format
		H (kHz)	V (Hz)		L720	L520	L720	L520	
NTSC/NTSC4.43/ PAL-M/PAL60	720 x 480i	15.734	59.940		A	A	OK	OK	Video/S-Video
PAL/PAL-N/SECAM	720 x 576i	15.625	50.000		A	A	OK	OK	Video/S-Video
525i	720 x 480i	15.734	59.940	13.500	A	A	OK	OK	YPbPr
625i	720 x 576i	15.625	50.000	13.500	A	A	OK	OK	YPbPr
525p	720 x 483	31.469	59.940	27.000	A	A	OK	OK	YPbPr
HDTV60	1 920 x 1 080i	33.750	60.000	74.250	A	A			YPbPr/RGB
HDTV50	1 920 x 1 080i	28.125	50.000	74.250	A	A			YPbPr/RGB
750P	1 280 x 720	45.000	60.000	74.250	A	A			YPbPr
VGA400	640 x 400	31.469	70.086	25.175	A	A	OK	OK	RGB
VGA480	640 x 400	37.861	85.081	31.500	A	A	OK	OK	RGB
	640 x 480	31.469	59.940	25.175	A	A	OK	OK	RGB
	640 x 480	35.000	66.667	30.240	A	A	OK	OK	RGB
	640 x 480	37.861	72.809	31.500	A	A	OK	OK	RGB
	640 x 480	37.500	75.000	31.500	A	A	OK	OK	RGB
SVGA	640 x 480	43.269	85.008	36.000	A	A	OK	OK	RGB
	800 x 600	35.156	56.250	36.000	A	AA	OK		RGB
	800 x 600	37.879	60.317	40.000	A	AA	OK		RGB
	800 x 600	48.077	72.188	50.000	A	AA	OK		RGB
	800 x 600	46.875	75.000	49.500	A	AA	OK		RGB
MAC16 XGA	800 x 600	53.674	85.061	56.250	A	AA	OK		RGB
	832 x 624	49.725	74.550	57.283	A	A	OK		RGB
	1 024 x 768	48.363	60.004	65.000	AA	A			RGB
	1 024 x 768	56.476	70.069	75.000	AA	A			RGB
	1 024 x 768	60.023	75.029	78.750	AA	A			RGB
MXGA	1 024 x 768	68.678	84.997	94.500	AA	A			RGB
	1 024 x 768i	35.520	86.952	44.897	AA	A			RGB
	1 152 x 864	63.995	71.184	94.200	A	A			RGB
	1 152 x 864	67.500	74.917	108.000	B	B			RGB
MAC21 MSXGA	1 152 x 864	76.705	85.038	121.500	B	C			RGB
	1 152 x 870	68.681	75.062	100.000	B	B			RGB
	1 280 x 960	60.000	60.000	108.000	B	C			RGB
SXGA	1 280 x 1 024	63.981	60.020	108.000	B	B			RGB
	1 280 x 1 024	79.977	75.025	135.001	B	C			RGB
	1 280 x 1 024	91.146	85.024	157.500	B	C			RGB
	1 400 x 1 050	63.981	60.020	108.000	B	B			RGB
UXGA	1 600 x 1 200	75.000	60.000	162.000	B	C			RGB

\*1 The "i" appearing after the resolution indicates an interlaced signal.

\*2 The following symbols are used to indicate picture quality.

AA Maximum picture quality can be obtained.

A Signals are converted by the image processing circuit before picture is projected

B Some loss of data occurs to make projection easier.

C Picture cannot be projected.

\*3 Signals with "OK" in the Resizing column can be set using the RESIZING command in the PICTURE menu. (Refer to page 39.)

# Dimensions

<Units: mm (inch)>

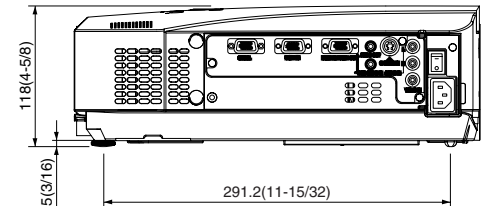
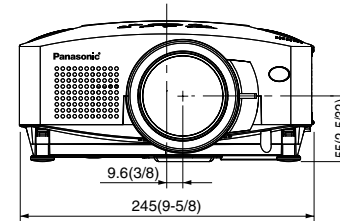
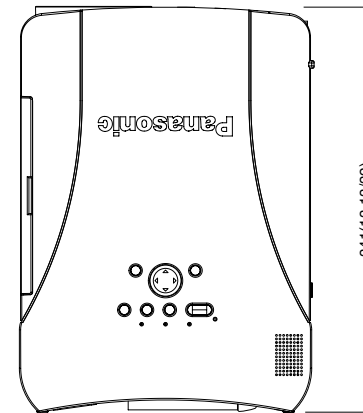

# Trademark acknowledgements

- VGA and XGA are trademarks of International Business Machines Corporation.
  - Macintosh is a registered trademark of Apple Computer, Inc.
  - S-VGA is a registered trademark of the Video Electronics Standards Association.
  - Windows is a registered trademark of Microsoft Corporation.
- All other trademarks are the property of the various trademark owners.

# NOTES IMPORTANTES CONCERNANT LA SÉCURITÉ

**AVERTISSEMENT: POUR REDUIRE LES RISQUES DE FEU OU DE CHOC ÉLECTRIQUE, NE PAS EXPOSER CE PRODUIT À L'EAU OU À L'HUMIDITÉ**

**Alimentation:** Ce projecteur LCD est conçu pour fonctionner sur secteur de 100 V - 240 V, 50 Hz/60 Hz seulement.

**ATTENTION:** Le cordon d'alimentation secteur fourni avec le projecteur peut être utilisé uniquement pour une alimentation électrique de 125 V, 10 A maximum. Si on veut l'utiliser avec une tension ou un courant plus forts, on doit se procurer un autre cordon d'alimentation de 250 V. Si on utilise le cordon fourni sous ces conditions, risque de provoquer un incendie.



Le symbole de la flèche en forme d'éclair, dans un triangle, avertit l'utilisateur de la présence de "tensions dangereuses" à l'intérieur du produit qui peuvent être de force suffisante pour constituer un risque de choc électrique aux personnes.



Le point d'exclamation dans un triangle avertit l'utilisateur de la présence d'instructions importantes concernant l'utilisation et l'entretien (réparation) dans la littérature accompagnant le produit.

**ATTENTION:** Cet appareil est équipé d'une fiche de courant à trois broches avec mise à la terre. Ne pas retirer la broche de mise à la masse de la fiche.

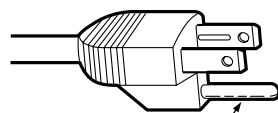

Ne pas retirer

Cette fiche ne pourra être utilisée que dans une prise avec mise à la terre. Ceci est une précaution sécuritaire. S'il est impossible d'insérer la fiche dans la prise, s'adresser à un électricien. Ne pas annuler la protection de la fiche à mise à la terre.

## Précautions de sécurité

### AVERTISSEMENT

En cas de problème (pas d'image ou de son), ou si le projecteur dégage de la fumée ou une odeur étrange, éteindre l'appareil et débrancher immédiatement la fiche d'alimentation de la prise de courant.

- Ne pas continuer d'utiliser le projecteur dans ces cas, autrement cela peut entraîner un incendie ou des chocs électriques.
- Après s'être assuré que de la fumée ne se dégage plus, s'adresser à un centre technique agréé et demander que les réparations nécessaires soient faites.
- Le fait de réparer le projecteur soi-même est très dangereux, et ne doit jamais être fait.

**Ne pas installer ce projecteur dans un endroit qui n'est pas assez résistant pour supporter le poids du projecteur.**

- Si l'emplacement d'installation n'est pas assez résistant, le projecteur risque de tomber et causer de graves blessures et (ou) des dommages.

**Demander à un technicien qualifié d'installer le projecteur par exemple s'il est installé au plafond.**

- Si l'installation n'est pas faite correctement, cela peut entraîner des blessures ou des chocs électriques.

**Si de l'eau ou des objets étrangers entrent dans le projecteur, si le projecteur tombe, ou si le boîtier est endommagé, éteindre l'appareil et débrancher immédiatement la fiche d'alimentation de la prise de courant.**

- Si l'on continue d'utiliser le projecteur dans cette condition, cela peut entraîner un incendie ou des chocs électriques.
- S'adresser à un centre technique agréé pour que les réparations nécessaires puissent être faites.

**Ne pas surcharger la prise de courant.**

- Si l'alimentation est surchargée (par exemple, par l'utilisation de trop d'adaptateurs), cela risque de faire surchauffer le projecteur et peut entraîner un incendie.

**Ne pas retirer le capot ou le modifier.**

- Des hautes tensions qui peuvent causer de graves blessures sont présentes à l'intérieur du projecteur.
- Pour toute inspection, réglage ou réparation, s'adresser à un centre technique agréé.

**Nettoyer la fiche du cordon d'alimentation régulièrement afin d'éviter toute accumulation de poussière.**

- Si de la poussière s'accumule sur la fiche du cordon d'alimentation, l'humidité peut endommager l'isolant et entraîner un incendie. Débrancher le cordon d'alimentation de la prise de courant et l'essuyer avec un chiffon sec.
- Si le projecteur n'est pas utilisé pendant une période prolongée, débrancher le cordon d'alimentation de la prise de courant.

**Faire attention à ne pas endommager le cordon d'alimentation.**

- Ne pas endommager le cordon d'alimentation, ne pas le modifier, ne pas placer sous des objets lourds, ne pas le chauffer, ne pas le placer près d'objets chauffants, ne pas le tordre, ne pas le plier ou le tirer excessivement et ne pas le rouler en boule.
- Si le cordon d'alimentation est endommagé, cela peut entraîner un incendie et des chocs électriques.
- Si le cordon d'alimentation est endommagé, le faire réparer par un centre technique agréé.

**Ne pas manipuler le cordon d'alimentation avec les mains mouillées.**

- Cela peut entraîner des chocs électriques.

**Brancher la fiche du cordon d'alimentation fermement dans la prise de courant.**

- Si la fiche n'est pas complètement insérée, cela peut entraîner des chocs électriques ou la faire surchauffer.
- Si la fiche est endommagée ou la plaque de la prise est desserrée, elles ne devraient pas être utilisées.

**Ne pas placer le projecteur sur des surfaces instables.**

- Si le projecteur est placé sur une surface qui est inclinée ou instable, il risque de tomber ou de se renverser et cela peut causer des blessures ou des dommages.

**Ne pas placer le projecteur dans l'eau ou ne pas le laisser se mouiller.**

- Sinon cela peut causer un incendie ou des chocs électriques.

**Ne pas placer des récipients de liquide sur le projecteur.**

- Si de l'eau se renverse sur le projecteur, s'adresser à un centre technique agréé.
- Si de l'eau entre à l'intérieur du projecteur, entrer en contact avec un centre technique agréé.

**Ne pas mettre d'objets étrangers dans le projecteur.**

- Ne pas insérer d'objets métalliques ou inflammables dans les orifices de ventilation ou les faire tomber sur le projecteur, car cela peut causer un incendie ou des chocs électriques.

**Garder la télécommande hors de portée des enfants, et ne pas regarder directement dans le rayon laser; ne pas pointer le rayon vers d'autres personnes.**

- Si l'on pointe directement vers les yeux le rayon laser émis par la télécommande, ceci risque d'endommager les yeux.

**Veiller à ce que les bornes + et - des piles n'entrent pas en contact avec des objets métalliques tels que des colliers ou des épingles à cheveux.**

- Sinon, les piles risqueront de fuir, de surchauffer, d'exploser ou de prendre feu.
- Ranger les piles dans un sac en plastique, et ne pas les ranger à proximité d'objets métalliques.

**Pendant un orage, ne pas toucher le projecteur ou le câble.**

- Il y a risque d'électrocution.

**Ne pas utiliser l'appareil dans un bain ou une douche.**

- Il y a risque d'incendie ou d'électrocution.

**Ne pas regarder directement dans la lentille pendant que le projecteur fonctionne.**

- Une lumière intense est émise par la lentille du projecteur. Si l'on regarde directement dans cette lumière, elle risque de causer des blessures et de graves lésions aux yeux.

**Ne pas placer ses mains ou autres objets près de la sortie d'air.**

- De l'air chaud sort par l'ouverture de sortie d'air. Ne pas placer les mains ou la figure, ou d'autres objets qui ne peuvent résister à la chaleur près de cette sortie d'air, sinon cela peut causer des blessures ou des dommages.

**Lors du remplacement de la lampe, la laisser refroidir pendant au moins une heure avant de la manipuler.**

- Le couvercle de la lampe devient très chaud, et on risque de se brûler si on le touche.

**Avant de remplacer la lampe, veiller à débrancher le cordon d'alimentation de la prise de courant.**

- Il y a risque d'électrocution ou d'explosion.

## Attention

**Ne pas obstruer les orifices d'entrée et de sortie d'air.**

- Cela risque de faire surchauffer le projecteur, et causer un incendie ou endommager le projecteur.

**Ne pas installer le projecteur dans des endroits humides ou poussiéreux ou dans des endroits où le projecteur peut entrer en contact avec de la fumée ou la vapeur.**

- L'utilisation du projecteur dans de telles conditions peut causer un incendie ou des chocs électriques.

### **Pour débrancher le cordon d'alimentation, tenir la fiche et non pas le cordon.**

- Si le cordon d'alimentation est tiré, le cordon sera endommagé et cela peut causer un incendie, des courts-circuits ou des chocs électriques sérieux.

### **Débrancher toujours tous les câbles avant de déplacer le projecteur.**

- Le fait de déplacer le projecteur avec des câbles branchés peut endommager les câbles, ce qui pourraient causer un incendie ou des chocs électriques.

### **Ne pas placer d'objets lourds sur le projecteur.**

- Cela peut déséquilibrer le projecteur et le faire tomber, ce qui peut entraîner des dommages ou des blessures.

### **Ne pas court-circuiter, chauffer ou démonter les piles, et ne pas les mettre dans l'eau ou dans le feu.**

- Sinon, les piles risqueront de surchauffer, de fuir, d'exploser ou de prendre feu, et donc de causer des brûlures ou d'autres blessures.

### **Lorsqu'on insère les piles, veiller à ce que les polarités (+ et -) soient bien respectées.**

- Si l'on insère les piles incorrectement, elles risqueront d'exploser ou de fuir, ce qui peut causer un incendie, des blessures ou une contamination du logement des piles et de la zone environnante.

### **Utiliser uniquement les piles spécifiées.**

- Si l'on utilise des piles incorrectes, elles risqueront d'exploser ou de fuir, ce qui peut causer un incendie, des blessures ou une contamination du logement des piles et de la zone environnante.

### **Ne pas mélanger des piles usées et des piles neuves.**

- Si l'on insère les piles incorrectement, elles risqueront d'exploser ou de fuir, ce qui peut causer un incendie, des blessures ou une contamination du logement des piles et de la zone environnante.

### **Ne pas peser de tout son poids sur ce projecteur.**

- On risque de tomber ou de casser l'appareil, ce qui peut causer des blessures.
- Veiller tout particulièrement à ce que des enfants ne montent pas sur l'appareil.

### **Débrancher la fiche du cordon d'alimentation de la prise de courant comme mesure de sécurité avant d'effectuer tout nettoyage.**

- Sinon cela peut causer des chocs électriques.

### **Demander à un centre technique agréé de nettoyer l'intérieur du projecteur au moins une fois par an.**

- S'il n'est pas nettoyé et que la poussière s'accumule à l'intérieur du projecteur, cela peut causer un incendie ou des problèmes de fonctionnement.

- Il est recommandé de nettoyer l'intérieur du projecteur avant que la saison humide n'arrive. Demander au centre technique agréé plus proche de nettoyer le projecteur lorsque cela est requis. Se renseigner auprès du centre technique agréé pour le coût du nettoyage.

**Nous faisons tous les efforts possibles afin de préserver l'environnement. Prière d'apporter l'appareil, s'il n'est pas réparable, à votre revendeur ou à un centre de recyclage.**

## **Précautions de manipulation**

### **Avertissements concernant la manipulation**

#### **S'assurer d'attacher le capuchon d'objectif avant de transporter le projecteur.**

La lentille de projection est extrêmement sensible à la vibration et aux chocs. Utiliser la sacoche de transport pour transporter le projecteur.

### **Avertissements concernant l'installation**

Toujours observer les points suivants lors de l'installation du projecteur.

#### **Éviter de l'installer dans les endroits sujets à des vibrations ou à des chocs.**

Si le projecteur est installé dans les endroits sujets à de fortes vibrations, comme près d'un moteur, ou s'il est installé à l'intérieur d'un véhicule ou à bord d'un bateau, le projecteur peut être soumis à une vibration ou à des chocs qui peuvent endommager les pièces internes et causer des mauvais fonctionnements ou des accidents. Dès lors, installer le projecteur dans un endroit qui n'est pas soumis à des vibrations ou des chocs.

#### **Ne pas installer le projecteur près de lignes d'alimentation électrique à haute tension ou de moteurs.**

Le projecteur peut être sujet à une interférence électromagnétique s'il est installé près de lignes d'alimentation électrique à haute tension ou de moteurs.

#### **Si le projecteur est installé au plafond, demander à un technicien qualifié de faire tous les travaux d'installation.**

Si le projecteur doit être suspendu au plafond, il faut acheter le kit d'installation séparé (numéro de modèle: ET-PK730). De plus, tous les travaux d'installation ne devraient être faits que par un technicien qualifié.

#### **Si l'on utilise ce projecteur à un endroit élevé (au-dessus de 1 400 m), régler le VENTILATEUR à HAUTE. (Se référer à la page 41.)**

Sinon, des anomalies pourront se produire.



## Notes sur l'utilisation

### Afin d'obtenir la meilleure qualité d'image

Si la lumière extérieure ou la lumière des lampes intérieures brille sur l'écran, les images projetées n'auront pas un bon contraste. Tirer les rideaux ou les stores de toutes les fenêtres et éteindre toutes les lumières fluorescentes près de l'écran pour empêcher la réflexion.

### Ne pas toucher aux surfaces de la lentille avec les mains nues.

Si la surface de la lentille est salie par des empreintes digitales ou autre, ceci sera agrandi et projeté sur l'écran. D'ailleurs, lorsque le projecteur n'est pas utilisé, rétracter la lentille, puis la couvrir à l'aide du capuchon d'objectif fourni.

### À propos de l'écran

Si l'écran utilisé est sale, endommagé ou décoloré, des projections de bonne qualité ne peuvent pas être obtenues. N'appliquer aucune substance volatile à l'écran et ne pas le laisser se salir ou s'endommager.

### A propos de la lampe

Il est possible qu'il faille remplacer la lampe plus tôt en raison de facteurs variables tels que des caractéristiques de la lampe, des conditions d'utilisation et un environnement d'installation particuliers, en particulier si elle est utilisée de façon continue pendant plus de 10 heures.

## Avant de faire le nettoyage et l'entretien, s'assurer de débrancher la fiche du cordon d'alimentation de la prise de courant.

### Essuyer le boîtier avec un tissu doux et sec.

Si le boîtier est très sale, imbiber le chiffon dans de l'eau avec un peu de détergent neutre, bien essorer le chiffon, puis essuyer le boîtier. Après le nettoyage, sécher le boîtier à l'aide d'un chiffon sec.

### Si un chiffon traité chimiquement est utilisé, lire les directives fournies avec le chiffon avant de l'utiliser.

Ne pas essuyer la lentille avec un chiffon poussiéreux ou pelucheux.

Si de la poussière ou de la peluche se dépose sur la lentille, elle sera agrandie et projetée sur l'écran. Utiliser une poire à air pour nettoyer toute poussière et peluche de sur la surface de la lentille, ou utiliser un chiffon doux pour retirer toute poussière ou peluche.

## Remplacement du bloc de lampe

### AVERTISSEMENT

Lors du remplacement de la lampe, la laisser refroidir pendant au moins une heure avant de la manipuler.

- Le couvercle de la lampe devient très chaud, et on risque de se brûler si on le touche.

### Notes sur le remplacement du bloc de lampe

- Faire très attention en manipulant le bloc de lampe retiré, car il contient du gaz sous haute pression et peut facilement s'endommager s'il est cogné contre des objets durs ou s'il tombe.
- La lampe produisant la lumière est en verre; elle risque donc d'éclater si on la laisse tomber ou si elle heurte des objets durs. Faire bien attention en manipulant la lampe.
- La lampe usagée qu'on a retirée risque d'éclater si on la jette sans prendre de précautions. Jeter la lampe de la même manière qu'une lampe fluorescente.

### REMARQUE:

- Le projecteur n'est pas fourni avec un bloc de lampe de rechange. Demander les détails au revendeur. Numéro de produit du bloc de lampe: **ET-LA730**

### ATTENTION:

- Ne pas utiliser un bloc de lampe avec un numéro de pièce autre que celui indiqué ci-dessus.



### Période de remplacement du bloc de lampe

La lampe est un produit qui doit être remplacé. Même si la durée de vie complète de l'ampoule n'est pas encore épuisée, la luminosité de la lampe diminuera progressivement. Il faut donc remplacer périodiquement la lampe.

L'intervalle de remplacement de la lampe prévu est de 2 000 heures; il est toutefois possible qu'il faille remplacer la lampe avant ce délai en raison d'éléments variables tels que les caractéristiques particulières de la lampe, les conditions d'utilisation et l'environnement d'installation. Il est recommandé de toujours avoir un bloc de lampe de rechange prêt à l'emploi. Une lampe qui a dépassé la limite de 2 000 heures d'utilisation risque beaucoup plus d'exploser. Afin d'éviter que la lampe explose, celle-ci est éteinte automatiquement lorsque la limite de 2 000 heures d'utilisation est atteinte.

### REMARQUE:

- Les heures d'utilisation expliquées ci-dessus concernent l'utilisation lorsque le réglage HAUTE a été sélectionné pour PUIS LAMPE dans le menu OPTION2. Si le réglage FAIBLE est sélectionné, la luminosité de la lampe sera moindre et la durée de vie de la lampe sera allongée.
- Bien que le délai de 2 000 heures soit l'intervalle de remplacement prévu, l'obtention de cette durée n'est pas couverte par la garantie.

	Affichage à l'écran 	Témoin d'alarme de l'indicateur de la lampe 
Plus de 1 800 heures	Affiché pendant 30 secondes. L'affichage disparaît si l'on appuie sur n'importe quelle touche.	Le projecteur passe en mode d'attente et l'indicateur rouge s'allume.
Plus de 2 000 heures	L'affichage ne peut pas être effacé, quelle que soit la touche sur laquelle on appuie.	

## Méthode de remplacement du bloc de lampe

### REMARQUE:

- Si le temps d'utilisation de la lampe a dépassé 2 000 heures (lorsque PUIS LAMPE a été mis sur "HAUTE"), le projecteur passe en mode d'attente après environ dix minutes de fonctionnement. Dès lors, faire les étapes ⑦ à ⑪ à la page suivante dans les 10 minutes.

- ① Mettre hors circuit l'interrupteur d'alimentation principale (MAIN POWER) suivant la méthode donnée dans "Mise hors circuit de l'alimentation" à la page 27, puis débrancher la fiche du cordon d'alimentation de la prise de courant et vérifier que les pièces autour du bloc de lampe se sont refroidies.

- ② Utiliser un tournevis Phillips pour desserrer les vis de fixation du couvercle du bloc de lampe sur le fond du projecteur, puis enlever le couvercle du bloc de lampe.

Couvercle de l'unité de lampe

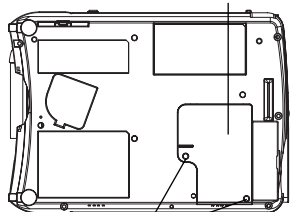

Vis de fixation du couvercle du bloc de lampe

- ③ Utiliser un tournevis Phillips pour desserrer les deux vis de fixation du bloc de lampe jusqu'à ce que les vis tournent librement. Tenir la poignée du bloc de lampe et tirer doucement pour le sortir du projecteur.

Vis de fixation du bloc de lampe

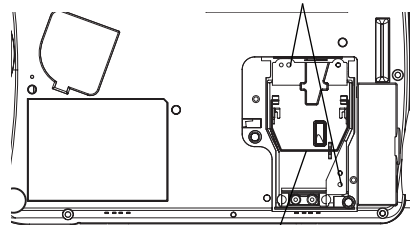

Poignée

- ④ Insérer le nouveau bloc de lampe tout en s'assurant que la direction de l'insertion est correcte, puis utiliser un tournevis Phillips pour resserrer fermement les vis de fixation du bloc de lampe.

- ⑤ Installer le couvercle du bloc de lampe, puis utiliser un tournevis Phillips pour resserrer fermement les vis de fixation du couvercle du bloc de lampe.

### REMARQUE:

- S'assurer de bien installer le bloc de lampe et le couvercle du bloc de lampe. S'ils ne sont pas bien installés, cela peut déclencher le circuit de protection et le projecteur ne pourra pas être allumé.

- ⑥ Insérer la fiche du cordon d'alimentation dans la prise de courant, puis appuyer sur l'interrupteur d'alimentation principale (MAIN POWER).

### REMARQUE:

- Si l'indicateur d'alimentation (POWER) du projecteur ne s'allume pas en rouge lorsque l'interrupteur d'alimentation principale (MAIN POWER) est mis sur la position de marche, mettre à nouveau l'interrupteur d'alimentation principale (MAIN POWER) sur la position d'arrêt et vérifier que le bloc de lampe et le couvercle du bloc de lampe soient bien installés.

- ⑦ Appuyer sur la touche d'alimentation (POWER) pour projeter une image sur l'écran.

- ⑧ Appuyer sur la touche de menu (MENU) pour afficher l'écran de MENU PRINCIPAL, puis appuyer sur les touches ▲ et ▼ pour déplacer le curseur et sélectionner "OPTION2".



- ⑨ Appuyer sur la touche d'entrée (ENTER) pour afficher le menu OPTION2, puis utiliser les touches ▲ et ▼ pour sélectionner DURÉE LAMPE.

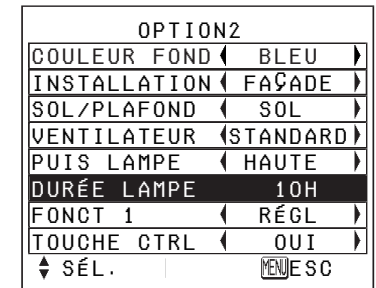

- ⑩ Maintenir la touche d'entrée (ENTER) enfoncée pendant environ 3 secondes.

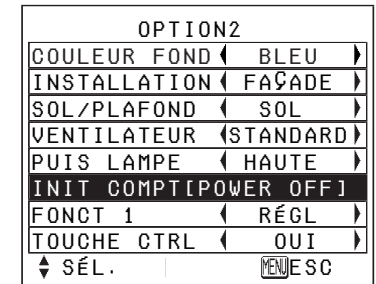

"DURÉE LAMPE" changera à "INIT COMPT [POWER OFF]".

### REMARQUE:

- Si la touche de menu (MENU) est pressée, l'écran de remise à zéro de la durée de lampe sera annulé.

- ⑪ Couper l'alimentation électrique. Le temps d'utilisation total du bloc de lampe est alors remis à zéro. Pour plus de détails concernant la mise hors tension, se reporter à la page 27.

These Operating Instructions are printed on recycled paper.

---

**Panasonic**<sup>®</sup>

Professional/Industrial Video

---

**Panasonic Broadcast & Television Systems Company**  
Division of Matsushita Electric Corporation of America

3330 Cahuenga Blvd West Los Angeles, CA 90068 (323) 436-3500

**Technical Support:**

(800) 222 - 0741

E-Mail: [pbtsservice@panasonic.com](mailto:pbtsservice@panasonic.com)

---

**Panasonic Canada Inc.**

5770 Ambler Drive, Mississauga, Ontario L4W 2T3 (905) 624-5010

Printed in Japan  
S0502-2072C